

# CAMPEON<sup>®</sup>

SINCE 1946

# 2022



Campeon

A detailed pencil-style sketch of a truck's front and side, rendered in shades of gray. The truck is angled towards the viewer. On the side of the truck's body, the word "Campeon" is written in a red, cursive script with a white outline. The sketch captures the textures of the metal and the various components of the truck, including the headlights, grille, and side mirrors.

# Campeón

DESDE  
1946





# DESDE SIEMPRE ESPECIALISTAS DEL MOTOR

En 1946 D. Francisco Peris y D. Juan Plana, ambos destacados técnicos del sector del motor, fundaron Famosa Fábrica de Motores, S.A.

Se inició la producción con motores de diseño propio, de cuatro tiempos a gasolina.

Posteriormente se fue ampliando el campo de producción de dos tiempos a gasolina y motores diésel.

A través de los años, gracias a su calidad y buen rendimiento, los motores, motobombas y grupos electrógenos CAMPEON se han ganado un prestigio reconocido en toda España y el extranjero.

Actualmente somos Fabricantes de Motores y Motobombas, Grupos electrógenos, Grupos de presión hidroneumáticos y Grupos contraincendios.

Distribuidores de maquinaria forestal, agrícola y de jardinería con marca CAMPEON o la exclusiva de marcas de prestigio internacional, como KOSHIN JAPAN, FORAS ITALY, MORI TAIWAN, etc...

Ponemos a disposición de nuestros más de 2.000 clientes en España, Portugal, Francia, Grecia, Alemania e Italia nuestra experiencia y ofrecemos una completa gama de productos que cubren cualquier necesidad tanto de cliente tradicional como de la ferretería especializada, con más de 100 puntos de asistencia técnica en nuestro País.

Nuestra pasión e imagen de marca, nos lleva a incorporar a nuestro catálogo los últimos avances técnicos, para así ofrecer a todos nuestros clientes una gama muy amplia de productos que puedan satisfacer todas sus necesidades.

Nuestro objetivo fundamental es dar el mejor asesoramiento y apoyo a nuestros clientes. Para ello disponemos de un equipo humano altamente profesional que, previo estudio individualizado de cada instalación se encarga de ofrecer soluciones a cualquier tipo de consulta.



Actuales instalaciones: 9.000 m<sup>2</sup> • Current facilities: 9.000 m<sup>2</sup> • Instalações atuais: 9.000 m<sup>2</sup> • Installations actuelles : 9.000 m<sup>2</sup>

Desde siempre especialistas del motor • It has ever been great as engines specialist • Desde sempre especialistas em motores • Des spécialistes du moteur depuis toujours





## IT HAS EVER BEEN GREAT AS ENGINES SPECIALIST

In 1946 Mr. Francisco Peris and Mr. Juan Plana, both outstanding technicians in the motor field founded Famosa Fábrica de Motores, S.A.

The production began with our own designed four-stroke gasoline engines.

Later on, the production was expanded by introducing two-stroke gasoline and diesel engines .

Through the years and thanks to their quality and good performance, CAMPEON engines, motor pumps and generators have gained a huge recognized prestige throughout Spain and abroad.

We are currently Manufacturers of Engines and Pumps, Generators, Hydropneumatic pressure groups and Fire-fighting groups.

Distributors of forestry, agricultural and gardening machinery with the CAMPEON brand and working in sole exclusive of international prestige brands such as KOSHIN JAPAN, FORAS ITALY, MORI TAIWAN, etc...

Our experience is at the entire disposal of our more than 2,000 clients in Spain, Portugal, France, Greece, Germany and Italy . Moreover, we offer a complete range of products that cover any need of both traditional clients

and specialized hardware stores with over 100 technical sales assistance points in our country.

Our passion and brand image lead us to incorporate the latest technical advances into our catalogue with the aim to offer all our clients a very wide range of products that can fulfill their needs completely.

Our main target is to give the best advice and support to our clients. Thus, we have a team of highly trained professionals that is responsible for offering solutions to any type of query prior to a careful individualized study.



**Primeras instalaciones: 4.000 m<sup>2</sup>**

First facilities: 4.000 m<sup>2</sup> • Primeiras instalações: 4.000 m<sup>2</sup> • Premières installations : 4.000 m<sup>2</sup>



# DESDE SEMPRE ESPECIALISTAS EM MOTORES

Em 1946 o Sr. Francisco Peris e o Sr. Juan Plana, ambos técnicos de destaque no setor automotivo, fundaram a Famosa Fábrica de Motores, S.A.

A produção começou com os nossos próprios motores a gasolina de quatro tempos.

Posteriormente, foi ampliada a produção de motores a gasolina e diesel de dois tempos.

Ao longo dos anos e face à sua qualidade e bom desempenho, os motores, motobombas e geradores CAMPEON ganharam um prestígio reconhecido em Espanha e no estrangeiro.

Somos Fabricantes de Motores e Motobombas, Grupos eletrogéneos, Grupos de pressão hidropneumáticos e Grupos contra incêndios.

Distribuidores de maquinaria florestal, agrícola e de jardinagem (fumigação, cortadores de relva, desbastadores, motoenxadas, cortadores de lenha, moto perfurador, lavadoras, motosserras, etc...), com marca própria CAMPEON ou a exclusiva de marcas de prestígio internacional, como KOSHIN JAPAN, FORAS ITALY, MORI TAIWAN, etc...

Colocamos à disposição dos nossos mais de 2.000 clientes em Espanha, Portugal, França, Grécia, Alemanha e Itália, a nossa experiência, e oferecemos uma completa gama de produtos que cobrem qualquer necessidade quer do cliente tradicional quer da serralharia especializada, com mais de 100 pontos de assistência técnica no nosso País.

A nossa paixão e imagem de marca, leva-nos a incorporar ao nosso catálogo os últimos avanços técnicos, para desta forma oferecer a todos os nossos clientes uma gama muito ampla de produtos que possam satisfazer todas as suas necessidades.



*Campeon*

Desde siempre especialistas del motor • It has ever been great as engines specialist • Desde sempre especialistas em motores • Des spécialistes du moteur depuis toujours



# DES SPÉCIALISTES DU MOTEUR DEPUIS TOUJOURS

En 1946, M. Francisco Peris et M. Juan Plana, tous deux éminents techniciens du secteur auto-tractions, fondèrent Famosa Fábrica de Motores, S.A.

La production a commencé avec des moteurs de dessin propre, à essence 4 temps

Par la suite, le domaine de production des moteurs a été élargi aux moteurs diesel et à essence 2 temps

Au fil des années, grâce à leur qualité et à leurs bonnes performances, les moteurs, motopompes et groupes électrogènes CAMPEON ont acquis un prestige reconnu dans toute l'Espagne et à l'étranger.

Actuellement nous fabriquons des Moteurs et des Motopompes, des Groupes électrogènes, des Groupes de Pression hydropneumatiques ainsi que des Groupes contre les incendies.

Nous sommes distributeurs de machines forestières, agricoles, de motoculture et jardins (Pulvérisation, tondeuses à gazon, débroussailleuses, motoculteurs, fendeuses à bois, des motos tarières, nettoyeurs Haute Pression, tronçonneuses, etc...) de la marque CAMPEÓN et distributeurs exclusifs de marques internationales prestigieuses telles que KOSHIN JAPAN, FORAS ITALY, MORI TAIWAN, etc...

Nous mettons à disposition de nos plus de 2000 clients en Espagne, au Portugal, en France, en Grèce, en Allemagne et en Italie, notre expérience et nous leur offrons une gamme complète de produits et machines qui couvre tous les besoins de la clientèle traditionnelle et professionnelle à la quincaillerie spécialisée, avec plus de 100 points d'assistance technique en Espagne.

Notre passion et notre image de marque, nous a amené à introduire dans notre catalogue les dernières technologies de pointe pour ainsi offrir à tous nos clients un éventail très large de produits qui peuvent satisfaire tous leurs besoins.

Notre principal objectif est d'offrir le meilleur conseil et soutien à nos clients. À cet effet, nous disposons d'une équipe à taille humaine hautement qualifiée qui, après chaque étude individualisée pour chaque installation, se charge de trouver des solutions à toutes les consultations.





# CONDICIONES GENERALES DE VENTA

**Precios:** Este catálogo no contiene precios de venta al público recomendados. Pueden solicitar la tarifa vigente aparte, que no incluyen I.V.A y pueden ser modificados por MOTORES CAMPEON sin previo aviso. Consulten puntualmente promociones a precio neto a su delegado comercial de zona.

**Apertura de cuenta / Primera operación:** La primera operación comercial con MOTORES CAMPEON siempre será contado por transferencia anticipada, para posteriormente abrir cuenta y asignar riesgo comercial.

**Portes:** A cargo del cliente mediante cargo en factura, salvo en pedidos de importe superior a 600€ neto en Península, a 1.000€ neto en Baleares que serán pagados sin cargo; Canarias, Ceuta, Melilla y Andorra, siempre franco Península.

No se admitirán reclamaciones de deterioro de mercancía, causadas por el transporte, cuando el consignatario no haya indicado la incidencia en el talón de entrega de la Agencia de transportes, indicando la incidencia del envío y comunicándola a MOTORES CAMPEON en un plazo máximo de 10 días desde la fecha de recepción de la mercancía.

**Garantía:** El período de garantía para la maquinaria es de 36 meses, uso profesional 12 meses, ó según Legislación vigente en el momento de la venta, contra defecto de fabricación, previo reconocimiento por nuestro servicio técnico, la garantía no cubre: piezas dañadas por desgaste normal, uso y/ó mantenimiento, partes dañadas por uso indebido y se perderá automáticamente si se efectúan modificaciones y/ó reparaciones en el producto sin autorización de MOTORES CAMPEON ó fuera del servicio de asistencia técnica autorizado, consulte en [www.campeon.es](http://www.campeon.es) relación de SAT.

**Producto :** MOTORES CAMPEON se reserva el derecho de efectuar modificaciones de especificaciones, sin previo aviso; las fotos son únicamente ilustrativas

**Facturación y condiciones de pago:** El pedido mínimo para derecho a descuento es de 100€ neto antes de impuestos y portes, MOTORES CAMPEON factura diariamente por albarán emitido, y las condiciones de pago son las siguientes:

- Pedido inferior a 300€ neto antes de impuestos y portes, giro a 30 días fecha factura.
- Pedido superior a 301€ neto antes de impuestos y portes, condiciones pactadas con el cliente en cumplimiento de la Ley 15/10 del 7 de julio del 2010.
- Pedido contado: Dto 1,5 % pronto pago.
- El incumplimiento en las condiciones de pago provocará, sin previo aviso, el cargo de los gastos e intereses de demora correspondientes.

**Impagados:** Todas nuestras operaciones se aseguran con contrato de seguro de crédito, caso de devolución de efectos se bloqueará automáticamente la cuenta, hasta la resolución del mismo, caso de segunda repetición de devolución de efectos se cerrará automáticamente la cuenta.

**Reserva de dominio:** La mercancía siempre es propiedad de MOTORES CAMPEON hasta el pago de la factura correspondiente, quedando el cliente obligado a la devolución de la maquinaria y/o equipos sin necesidad de procedimiento especial alguno.

#### **Devolución de mercancía:**

- No se aceptan devoluciones de mercancía transcurridos 15 días desde la emisión del albarán de entrega.
- Cualquier devolución debe ser siempre previamente autorizada por CAMPEON, solicitando nº de devolución que deberá estar indicado tanto en el albarán de devolución como en el embalaje del producto devuelto.
- Las devoluciones serán siempre a portes pagados.
- No se efectuarán abonos de materiales que no estén en condiciones de venta o que les falte el embalaje.
- El abono de dicho material se realizará con una reducción, gastos a parte, del 15% sobre el precio que hubiese sido facturado, en concepto de manipulación.
- El importe de la devolución quedará en depósito para su descuento en próximas compras.

**PD:** En ningún caso aceptaremos mercancía a PORTE DEBIDO en nuestras instalaciones.



# CONDITIONS GENERALES DE VENTE

**Prix:** Ce catalogue ne contient pas de prix de vente conseillés. Il faut demander séparément le tarif en vigueur qui peut être modifié par MOTORES CAMPEON sans préavis. Il faut aussi consulter les promos prix net en vigueur

**Transport:** Franco à partir de 800€ net. Pour des commandes inférieures, un forfait de transport de 18€ pour les produits complets et de 12€ pour les pièces détachées sera facturé.

Les marchandises voyagent aux risques et périls du client, auquel il appartient de vérifier le bon état des marchandises au moment même de leur livraison.

Aucune réclamation ne sera acceptée si les réserves ne sont pas stipulées sur le bordereau-récépissé du transporteur à la livraison des marchandises et communiquées à Motores CAMPEON dans un délai maximum de 10 jours à compter de cette date de livraison.

**Garantie:** La période de garantie est de 36 mois à l'utilisateur final, 12 mois à l'utilisateur professionnel, contre tout défaut de fabrication dûment démontré. Notre service technique doit autoriser la garantie préalablement. La garantie ne couvre pas les pièces d'usure normale de la machine ou les avaries dues à un mauvais entretien ou une utilisation indue. La garantie se perdra automatiquement si les produits sont modifiés ou réparés sans l'autorisation de MOTORES CAMPEON.

**Produit:** MOTORES CAMPEON se réserve le droit d'apporter des modifications, sans préavis; les photos sont simplement illustratives

## Facturation et conditions de paiement:

- Les commandes minimum de produits finis seront de 300€, il n'y a pas de commandes minimum pour les pièces détachées.
- Les délais de paiement accordés seront valables pour factures d'un montant supérieur à 300€, pour factures d'un montant inférieur à 300€ le paiement sera immédiat.
- L'inaccomplissement des conditions de paiement produira, sans préavis, le chargement des frais et intérêts.

**Factures impayées:** Les opérations sont assurées et dans le cas de factures impayées, la ligne de crédit sera automatiquement bloquée, jusqu'à sa régularisation. A la deuxième facture impayée la ligne de crédit sera automatiquement annulée.

**Réserve de propriété de la marchandise:** La marchandise reste propriété de MOTORES CAMPEON, jusqu'au paiement complet des factures.

## Rendus de la marchandise:

- MOTORES CAMPEON n'accepte pas des retours de marchandises après les 15 jours de l'émission du bordereau de livraison.
- Tous les retours doivent toujours être préalablement autorisés par MOTORES CAMPEON, avec le n° de retour donné par MOTORES CAMPEON qui devrait être indiqué tant sur le bon de livraison de retour que dans l'emballage du produit à retourner.
- Les frais de transport du retour devront être toujours payés par le client.
- Aucun avoir sera émis si le matériel n'est pas complètement nouveau ou si l'emballage manque.
- L'avoir du matériel sera effectué avec une réduction du prix d'achat du 15%, en concept de manipulation et révision.
- Le montant de l'avoir sera déduit de futurs achats.

**SAV:** Barcelone:  
E.mail: [comercial@campeon.es](mailto:comercial@campeon.es)  
Fax: +34-935444422  
Tel: +34-902365015





# CONDIÇÕES GERAIS DE VENTA

**Preços:** Este catálogo não contém preços de venda recomendados. Podem solicitar a tabela de preços em vigor à parte, que não inclui IVA e podem ser modificadas pela MOTORES CAMPEON sem aviso prévio. Consultem pontualmente promoções a preços líquidos ao seu Delegado Comercial de zona.

**Portes:**

- 1 - Encomendas inferiores a 800€ Iq. A cargo do cliente e introduzidos na factura (Máquinas - 18€, Acessórios - 12€).
- 2 - Encomendas superiores a 800 € Iq. Portes pagos.
- 3 - Encomendas para Açores e Madeira. Portes a cargo do cliente com Transitário a designar.

Não se admitem reclamações da mercadoria causadas pelo transporte se o cliente não tiver mencionado a incidência na guia de entrega da Transportadora. Qualquer anomalia detetada deverá ser comunicada a MOTORES CAMPEON no prazo máximo de 10 dias após a recepção da mercadoria.

**Garantia:** O período de garantia para a maquinaria é de 36 meses, uso profissional 12 meses, ou segundo Legislação vigente no momento da venda, contra defeito de fabricação, prévio reconhecimento pelo nosso serviço técnico, a garantia não cobre : perde-se automaticamente se houverem modificações e/ou reparações no produto sem autorização de MOTORES CAMPEON ou fora do serviço de assistência técnica autorizado.

O serviço de SAT está centralizado no escritório de Barcelona, e.mail: comercial@campeon.es, Tel. 0034-902365015 Fax: 0034-935444422.

**Produto:** MOTORES CAMPEON reserva-se o direito de fazer alterações nas especificações sem aviso prévio; as fotos são apenas ilustrativas

**Faturação e condições de pago:** La encomenda mínima para direito a desconto é de 100 EUR LQ., antes de impostos e portes, MOTORES CAMPEON factura diariamente por recibo de entrega emitido, e as condições de pago são as seguintes:

- Encomenda inferior a 300€ LQ., antes de impostos e portes, cheque a 30 dias data factura.
- Encomenda superior a 301€ LQ., antes de impostos e portes, condições determinadas com o cliente.
- Encomenda à vista: Dto. 1,5 % pronto pago.
- O descumprimento nas condições de pago provocará, sem prévio aviso, o cargo dos gastos e despesas inerentes à demora causada.

**Impagados:** Todas as nossas operações são garantidas com contrato de seguro de crédito, caso se verifiquem devoluções de cheques a conta ficará bloqueada até à resolução do pagamento em causa se houver repetição do episódio anterior a conta do cliente ficará encerrada automaticamente.

**Reserva de domínio:** A mercadoria é sempre propriedade de MOTORES CAMPEON até à liquidação da factura correspondente caso não cumpra com o pagamento o cliente será obrigado a devolver a mercadoria em bom estado com portes a seu cargo para MOTORES CAMPEON.

**Devolução de mercadoria:**

- Não se aceitam devoluções de mercadoria passados 15 dias desde a emissão da guia de remessa de entrega.
- Qualquer devolução deve ser sempre previamente autorizada por MOTORES CAMPEON, solicitando nº de devolução que deverá estar indicado tanto na guia de remessa de devolução como na embalagem do produto devolvido.
- As devoluções são sempre a portes pagos pelo cliente.
- Não se efectuam créditos/ abonos de materiais que não estejam nas devidas condições de venda ou que lhes falte a embalagem original.
- Crédito / abono do citado material realizar-se-á com uma redução, gastos à parte, de 15% sobre o preço facturado inicialmente, para despesas de manipulação.
- Valor da devolução fica em depósito sendo descontado nas próximas compras de produtos.

**OBS:** Em nenhum caso aceitaremos mercadoria com portes a pagar em nossas instalações.

# ÍNDICE

INDEX  
ÍNDICE

<b>CONDICIONES GENERALES DE VENTA</b> CONDITIONS GENERALES DE VENTE / CONDIÇÕES GERAIS DE VENTA	<b>3</b>
<b>DELEGACIONES</b> DÉLÉGATIONS / DELEGAÇÕES	<b>12</b>
<b>MOTORES GASOLINA/DIESEL 4 TIEMPOS</b> MOTEURS ESSENCE/DIESEL 4 TEMPS / MOTORES GASOLINA/DIESEL 4 TEMPO	<b>13</b>
<b>MOTOBOMBAS GASOLINA 2 TIEMPOS</b> MOTOPOMPES ESSENCE 2 TEMPS / MOTOBOMBAS GASOLINA 2 TEMPOS	<b>15</b>
<b>MOTOBOMBAS GASOLINA 4 TIEMPOS</b> MOTOPOMPES ESSENCE 4 TEMPS / MOTOBOMBAS GASOLINA 4 TEMPOS	<b>17</b>
<b>ACCESORIOS MOTOBOMBAS</b> ACCESSOIRES MOTOPOMPES / ACESÓRIOS MOTOBOMBAS	<b>26</b>
<b>ELECTROBOMBAS</b> ELECTROPOMPES / BOMBAS ELÉCTRICAS	<b>27</b>
<b>JARDÍN</b> JARDIN / JARDIN	
<b>GAMA KOSHIN-PULVERIZADORES</b> GAMME KOSHIN-PULVERISATEURS / GAMA KOSHIN-PULVERIZADORES	<b>42</b>
<b>CARRETILLAS PULVERIZADORAS</b> PULVERISATEURS SUR CHASSIS / CARROS PULVERIZADORES - CAMPEON 2T/4T	<b>44</b>
<b>ACCESORIOS OPCIONALES PARA CARRETILLAS</b> ACCESSOIRES OPTIONNELS POUR PULVERISATEURS / ACESÓIRES OPCIONAIS PARA CARROS	<b>49</b>
<b>ASPIRADORES SOPLANTES TRITURADORES</b> ASPIRATEURS-SOUFFLEURS-BROYEURS / ASPIRADORES-SOPRADORES-TRITURADORES	<b>50</b>
<b>CORTACESPEDES</b> TONDEUSES / CORTARELVAS	<b>51</b>
<b>MOTOAZADAS - MOTOCULTORES</b> MOTOBINEUSES-MOTOCULTEURS / MOTOENXADAS-MOTOCULTIVADORES	<b>54</b>
<b>ACCESORIOS MOTOAZADAS</b> ACCESSOIRES MOTOBINEUSES / ACESÓRIOS MOTOENXADAS	<b>65</b>
<b>HENDEDORES DE LEÑA</b> FENDEUSE DE BÛCHES / MACHADOS PARA MADEIRA	<b>68</b>
<b>SIERRAS CIRCULARES PARA LEÑA</b> SCIE CIRCULAIRE À BÛCHES / SERRA CIRCULARES PARA LENHA	<b>69</b>
<b>MOTO-BARRENAS</b> TARIERES A MOTEUR/ PERFURADOR	<b>70</b>

<b>BARRENAS</b> MECHES/ BROCAS	71
<b>DESBROZADORAS</b> DEBROUSSAILLEUSES/ ROÇADORAS	72
<b>ACCESORIOS DE PROTECCIÓN Y RECAMBIOS DE CONSUMO</b> ACCESSOIRES DE PROTECTION ET DE RECHANGES / ACESSÓRIOS DE PROTECÇÃO E PEÇAS DE CONSUMO	77
<b>MOTOSIERRAS Y CORTASETOS</b> TRONÇONNEUSES ET TAILLE-HAIES / MOTOSERRAS E CORTA-SEBES	78
<b>VAREADORES RECOLECTORES DE ACEITUNAS</b> OUTILS RECOLTE OLIVES / VAREJADORES RECOLHEDORES DE AZEITONAS	79
<b>CARRETILLAS DE TRANSPORTE</b> TRANSPORTEURS A CHENILLES / CARROS DE TRANSPORTE	80
<b>MAQUINAS A BATERIA</b> OUTILS À BATTERIE / MÁQUINAS DE BATERIA	82
<b>BIOTRITURADORES GASOLINA</b> BROYEURS THERMIQUES / BIOTRITURADORES A GASOLINA	85
<b>MOTOSEGADORAS</b> MOTOFACHEUSES / MOTOSEGADORAS	86
<b>HIDROLIMPIADORAS</b> NETTOYEURS HAUTE-PRESSION / MÁQUINAS DE LAVAR DE ALTA PRESSÃO	87
<b>GRUPOS ELECTROGENOS</b> GROUPES ÉLECTROGÈNES / GRUPOS GERADORES DE ENERGIA	95
<b>MOTOSOLDADORAS</b> GROUPES DE SOUDAGE / MOTOSOLDADORA	101
<b>ALTERNADORES CON TOMA DE FUERZA PARA TRACTOR</b> ALTERNATEURS AVEC PRISE DE FORCE TRACTEUR / ALTERNADORES COM TRATOR PTO	102
<b>ACCESORIOS EN HIERRO</b> ACCESSOIRES EN FER / ACESSÓRIOS DE FERRO	107
<b>ACCESORIOS EN ACERO INOXIDABLE AISI 304</b> ACCESSOIRES EN ACIER INOX AISI 304 / ACESSÓRIOS AÇO INOXIDÁVEL AISI 304	125
<b>ACCESORIOS EN PLÁSTICO</b> ACCESSOIRES EN PLASTIQUE / ACESSÓRIOS EM PLÁSTICO	133
<b>MANGUERAS</b> TUYAUX / MANGUEIRAS	140
<b>INFORMACIÓN TÉCNICA</b> INFORMATION TECHNIQUE / INFORMAÇÃO TÉCNICA	142

# DELEGADOS ESPAÑA Y PORTUGAL

## DELEGADOS ESPANHA E PORTUGAL

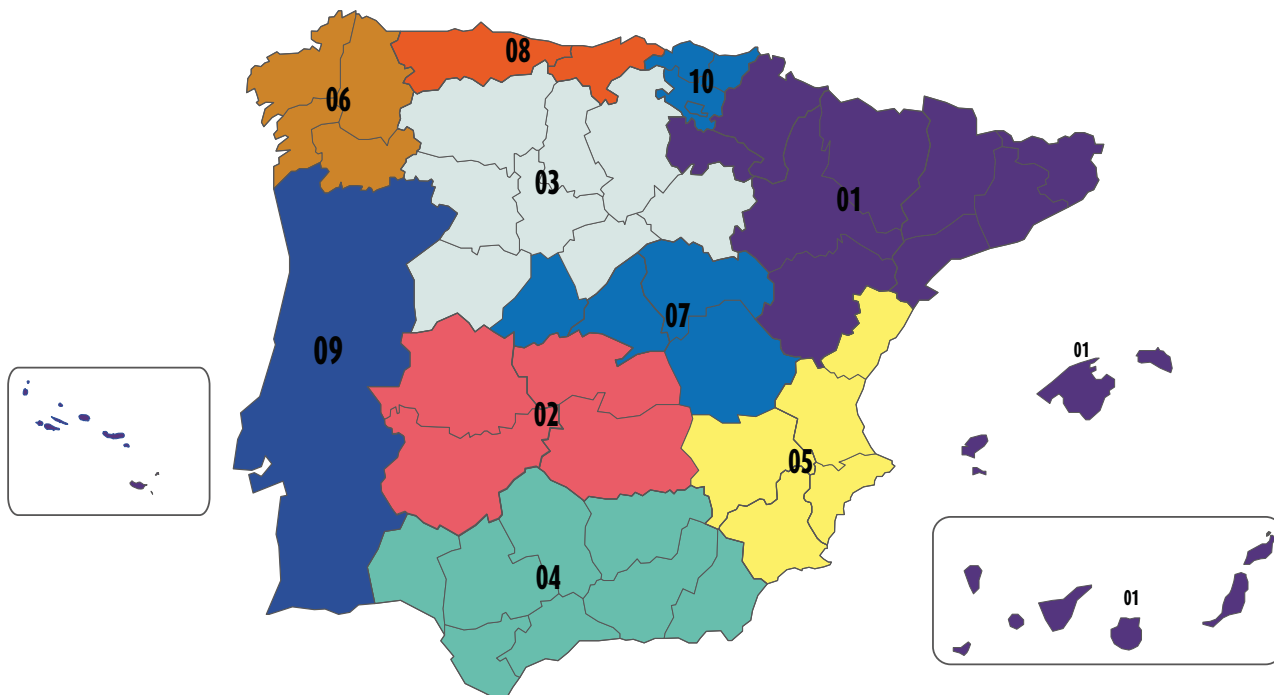

### 01 JORDI ACEREDA

Barcelona, Tarragona, Lérida, Gerona, Baleares, Zaragoza, Huesca, Teruel, Navarra, La Rioja, Canarias

### 02 JAVIER GARCÍA

Badajoz, Cáceres, Toledo, Ciudad Real

### 03 DANIEL CALAVIA

León, Palencia, Burgos, Segovia, Soria, Zamora, Valladolid, Salamanca

### 04 JAVIER GARCÍA JR

Huelva, Córdoba, Sevilla, Cádiz, Málaga, Jaén, Granada, Almería, Ceuta y Melilla

### 05 RICARDO NAVARRO

Castellón, Valencia, Alicante, Albacete, Murcia (+Primeros equipos fumigación)

### 06 GUMERSINDO ARGIZ

La Coruña, Lugo, Orense, Pontevedra

### 07

### 10 OFICINAS EN BARCELONA

Madrid, Guadalajara, Cuenca, Avila, Vizcaya, Guipúzcoa, Álava

### 08 JUAN M. VALDÉS

Asturias, Cantabria

### 09 MARIO VIDEIRA

Portugal

01	JORDI ACEREDA	jacereda@campeon.es	661 834 953
02	JAVIER GARCÍA	jpgarcia@tecnoplus.es	667 402 404
03	DANIEL CALAVIA	daniel@calaviarepresentaciones.es	695 566 863
04	JAVIER GARCÍA JR	jgarciajr@campeon.es	672 277 664
05	RICARDO NAVARRO	rnavarro@enagarsl.com	690 613 030
06	GUMERSINDO ARGIZ	gumercomercial@gmail.com	686 424 024
07 - 10	OFICINAS EN BARCELONA	info@campeon.es	935 444 420
08	JUAN M. VALDÉS	valdes.representaciones@gmail.com	609 610 710
09	MARIO VIDEIRA	mvideira@campeon.es	913 766060

Cooperativas, Asociaciones de Compra	JUAN CARLOS REBOLLO	jcrebollo@campeon.es	671 639 721
Servicio Asistencia Técnica (Postventa)	ENRIQUE VAQUERO	evaquero@campeon.es	678 405 622
Gestión pedidos productos acabados	JAVIER JURADO	jjurado@campeon.es	935 444 420
Gestión pedidos Recambios	MONTSE PERIS	mperis@campeon.es	935 444 420
Contabilidad	ISABEL PIÑOL	ipinyol@tecnoplus.es	935 444 420

# MOTORES GASOLINA/DIESEL 4 TIEMPOS

## MOTEURS ESSENCE/DIESEL 4 TEMPS

### MOTORES GASOLINA/DIESEL 4 TEMPOS

**RCX-80**
**ALERT OIL**

**RCX-210**
**ALERT OIL**

**ECO-200**
**ALERT OIL**

**ECO-270**
**ALERT OIL**

	RCX-80	ECO-200	RCX-210	RCX-210L	ECO-270S	ECO-390S	GE-178D	D-350F	D-350F E-START
Tipo Type Serie	Gasolina 4 tiempos • Essence 4 temps • Gasolina 4 tempos						Diesel	Diesel	Diesel
Diámetro Diamètre Diámetro (mm)	48,63	68	70	70	77	88	78	78	78
Carrera Alésage Carreira (mm)	43	54	55	55	58	64	62	73	73
Cilindrada Cylindrée Cilindrada (cm³)	80	196	212	212	270	389	296	349	349
Potencia kW/rpm Puissance ch/tr/mn	1,7/3600	4,1/3600	4,4/3600	4,4/1800	6/3600	8,2/3600	4,5/3600	4,9/3600	4,9/3600
Refrigeración Refruidissement Refrigeração	Aire Air Ar								
Filtro de aire Filtre à air Filtro de ar	RCX-80	Semiseco • Demi-sec • Semi-seco							
	S-TYPE/L-TYPE	Semihúmedo+cartucho papel • Demi humide+cartouche papier • Semi-úmido+cartucho de papel							
	Q-TYPE/ C-TYPE/DIESEL	Filtro en baño de aceite • Filtre à bain huile • Filtro em banho de óleo							
Encendido Allumage Ignição	Volante electrónico(CDI) • Valant électronique (CDI) • Volante electronico(CDI)								
Arranque Démarrage Arranque	Manual • Manuel • Manual								Eléctrico Électrique Elétrico
Paro Arrêt Stop	Interruptor manual • Interrupteur manuel • Interruptor manual								
Depósito Réservoir Tanque de combustível (L)	1,6	3,6	3,6	3,6	6	6,5	3,5	3,5	3,5
Peso Poids Peso (Kg)	9,5	16	16	16	25	31	33	39	44
Dimensiones Dimensions Dimensões	243x343x298	376x312x335	390x320x345		430x380x410	405x450x443	480x450x525	400x440x460	

# MOTORES GASOLINA/DIESEL 4 TIEMPOS

## MOTEURS ESSENCE/DIESEL 4 TEMPS

### MOTORES GASOLINA/DIESEL 4 TEMPOS

ECO-390

ALERT OIL



GE-178D

DIESEL



D-350F

DIESEL



Modelo Modèle Modelo	Código Code Código	Salida Sortie Saída
RCX-80	9330	Cilíndrica Ø 15mm <i>Cylindrique Ø 15mm</i> Cilíndrico Ø 15mm
ECO-200C <sup>(1)</sup>	8483C	Cónico <i>Conique</i> Cónico
ECO-200C-TM900 <sup>(4)</sup>	8483R-TM900	Estriado <i>Strié</i> Estriado
ECO-200S	8482	Cilíndrica Ø 20mm <i>Cylindrique Ø 20mm</i> Cilíndrico Ø 20mm
ECO-200Q	8483	Cilíndrica Ø 19,05mm <i>Cylindrique Ø 19,05mm</i> Cilíndrico Ø 19,05mm
RCX-210C <sup>(3)</sup>	8483CPRO	Cónico <i>Conique</i> Cónico
RCX-210S	9165	Cilíndrica Ø 20mm <i>Cylindrique Ø 20mm</i> Cilíndrico Ø 20mm
RCX-210Q	9170	Cilíndrica Ø 19,05mm <i>Cylindrique Ø 19,05mm</i> Cilíndrico Ø 19,05mm
RCX-210L	9175	Cilíndrica Ø 20mm <i>Cylindrique Ø 20mm</i> Cilíndrico Ø 20mm
ECO-270S	9230	Cilíndrica Ø 25mm <i>Cylindrique Ø 25mm</i> Cilíndrico Ø 25mm
ECO-390S	9235	Cilíndrica Ø 25mm <i>Cylindrique Ø 25mm</i> Cilíndrico Ø 25mm
GE-178D <sup>(2)</sup>	8576	Cónico <i>Conique</i> Cónico
D-350F <sup>(5)</sup>	9915R-TM900D	Estriado <i>Strié</i> Estriado
D-350F E-START <sup>(5)</sup>	9915R-TM900DE	Estriado <i>Strié</i> Estriado
ECO-270Q <sup>(6)</sup>	9230R-TM720GX	Cilíndrica Ø 19,05mm <i>Cylindrique Ø 19,05mm</i> Cilíndrico Ø 19,05mm
GE178DE <sup>(7)</sup>	8576R-TM720DX	Cilíndrica Ø 19,05mm <i>Cylindrique Ø 19,05mm</i> Cilíndrico Ø 19,05mm
Acoplamiento RCX-80 / RCX-100	32500	Helicoidal Ø 15mm <i>Hélicoïdal Ø 15mm</i> Helicoidal Ø 15mm Helicoidal Ø 14mm <i>Hélicoïdal Ø 14mm</i> Helicoidal Ø 14mm

<sup>(1)</sup>Versión especial motoazadas TM-500G/G2R

<sup>(1)</sup>Version spéciale motobineuses TM-500G/G2R

<sup>(1)</sup>Versão especial motoenxadas TM-500G/G2R

<sup>(2)</sup>Versión especial motoazadas TM-1000D

<sup>(2)</sup>Version spéciale motobineuses TM-1000D

<sup>(2)</sup>Versão especial motoenxadas TM-1000D

<sup>(3)</sup>Versión especial motoazadas TM-500G2R PRO

<sup>(3)</sup>Version spéciale motobineuses TM-500G2R PRO

<sup>(3)</sup>Versão especial motoenxadas TM-500G2R PRO

<sup>(4)</sup>Versión especial motoazadas TM-900G

<sup>(4)</sup>Version spéciale motobineuses TM-900G

<sup>(4)</sup>Versão especial motoenxadas TM-900G

<sup>(5)</sup>Versión especial motoazadas TM-900D

<sup>(5)</sup>Version spéciale motobineuses TM-900D

<sup>(5)</sup>Versão especial motoenxadas TM-900D

<sup>(6)</sup>Motocultor TM720-GX

<sup>(6)</sup>Motocultor TM720-GX

<sup>(6)</sup>Motocultor TM720-GX

<sup>(7)</sup>Motocultor TM720-DX

<sup>(7)</sup>Motocultor TM720-GX

<sup>(7)</sup>Motocultor TM720-GX

# MOTOBOMBAS GASOLINA 2 TIEMPOS

## MOTOPOMPES ESSENCE 2 TEMPS

### MOTOBOMBAS GASOLINA 2 TEMPOS

**AT-25**

**MADE IN JAPAN**



**AT-25 KIT**

**MADE IN JAPAN**



	AT-25	AT-25 KIT
cm <sup>3</sup>	26 cm <sup>3</sup>	26 cm <sup>3</sup>
KW	0,70	0,70
máx (l/h)	6.600	6.600
máx (m)	32	32
ASP. máx (m)	8	8
	1"	1"
mm	25	25
(h)	0,85	0,85
<b>LWA</b> dB(A)	110	110
mm	358x263x323	358x263x323 + 380x290x190
Peso Poids Peso (Kg)	5,5	9,5
	✓	✓
	NO	5 m
	NO	12 m
<b>AUTO ASPIRANTE</b> <b>AUTO AMORÇANTE</b>	✓	✓
Código Code Código	<b>3100</b>	<b>3100K</b>

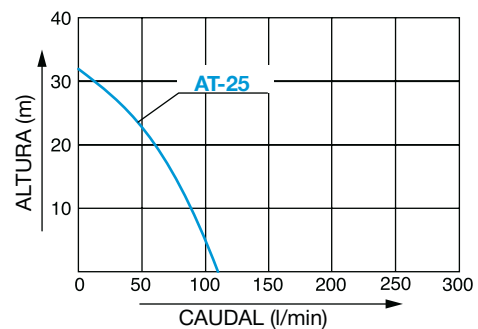

# MOTOBOMBAS GASOLINA 2 TIEMPOS

MOTOPOMPES ESSENCE 2 TEMPS

MOTOBOMBAS GASOLINA 2 TEMPOS

## GPUMP-25

















## GPUMP-25 KIT



## GPUMP-40



	GPUMP-25	GPUMP-25 KIT	GPUMP-40
 cm <sup>3</sup>	33	33	42,7
 KW	0,9	0,9	1,25
 máx (l/h)	7.500	7.500	16.800
 máx (m)	18	18	30
ASP. máx (m)	6	6	6
 GAS	1"	1"	1 1/2"
 mm	25	25	40
 (h)	1	1	1
<b>LWA</b> dB(A)	117	117	117
 mm	390x280x390	390x280x390 + 380x290x190	410x310x430
Peso Poids Peso (Kg)	7,5	11,5	9,5
	✓	✓	✓
	NO	5 m	NO
 IMP	NO	12 m	NO
 AUTO ASPI- RANTE	✓	✓	✓
 AUTO AMOR- CANTE			
 AUTO ASPI- RANTE			
Código Code Código	9418	9418K	9419

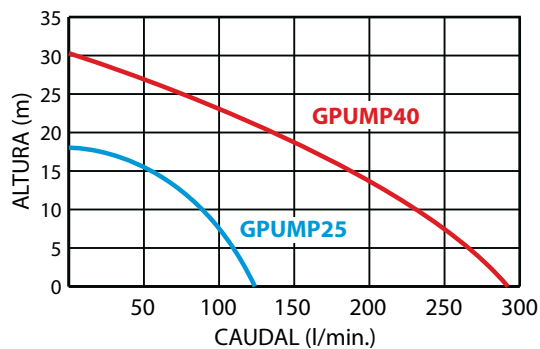



# MOTOBOMBAS GASOLINA 4 TIEMPOS

## MOTOPOMPES ESSENCE 4 TEMPS

### MOTOBOMBAS GASOLINA 4 TEMPOS

**MRC-25**

**ALERT OIL**



**MRC-40**

**ALERT OIL**



**MRX-50**

**ALERT OIL**



**MRX-80**













**ALERT OIL**



**MRX-100**

**ALERT OIL**



	MRC-25	MRC-40	MRX-50	MRX-80	MRX-100
 cm <sup>3</sup>	80	80	212	212	270
 KW	1,7	1,7	4,4	4,4	6,0
 máx (l/h)	12.000	15.000	36.000	60.000	96.000
 máx (m)	36	20	25	28	30
ASP. máx (m)	6	5	7	7	7
 GAS	1"	1"1/2	2"	3"	4"
 mm	25	40	50	75	100
 (h)	2	2	2	2	2
<b>LWA</b> dB(A)	97	97	104	104	108
 mm	385X285X375	370X320X405	505x420x435	525x420x470	625x455x565
Peso Poids Peso (Kg)	13	13	25	27	43
	✓	✓	✓	✓	✓
 AUTO ASPIRANTE	✓	✓	✓	✓	✓
 AUTO AMORÇANTE	✓	✓	✓	✓	✓
 AUTO ASPIRANTE	✓	✓	✓	✓	✓
Código Code Código	<b>9364</b>	<b>9365</b>	<b>5870</b>	<b>5875</b>	<b>5880</b>

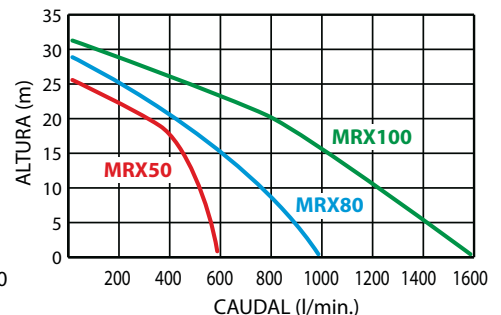
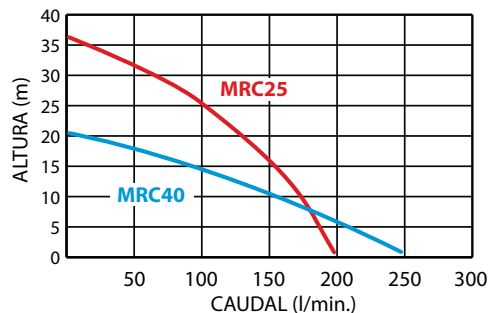

# MOTOBOMBAS GASOLINA 4 TIEMPOS

MOTOPOMPES ESSENCE 4 TEMPS

MOTOBOMBAS GASOLINA 4 TEMPOS

MRX-50 NEW

ALERT OIL



MRX-80 NEW

ALERT OIL



	MRX-50 NEW	MRX-80 NEW
cm <sup>3</sup>	212	212
KW	4,4	4,4
máx (l/h)	36.000	60.000
máx (m)	30	30
ASP. máx (m)	7	7
GAS	2"	3"
mm	50	75
(h)	2	2
LWA dB(A)	104	104
mm	505x420x435	525x420x470
Peso Poids Peso (Kg)	25	29
	✓	✓
AUTO ASPI-RANTE	✓	✓
AUTO AMOR-ÇANTE		
AUTO ASPI-RANTE		
Código Code Código	5870N	5875N

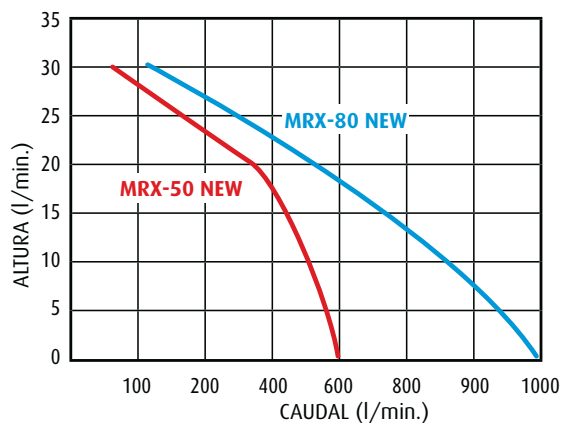

# MOTOBOMBAS GASOLINA 4 TIEMPOS

## MOTOPOMPES ESSENCE 4 TEMPS

### MOTOBOMBAS GASOLINA 4 TEMPOS

MRV-50

ALERT OIL



MRV-80

ALERT OIL



MRQ-50

ALERT OIL



MRW-80

ALERT OIL



	MRV-50	MRV-80	MRQ-50	MRW-80
cm <sup>2</sup>	212	212	212	212
KW	4,4	4,4	4,4	4,4
máx (l/h)	30.000	16.000	32.000	45.000
máx (m)	50	80	35	25
ASP. máx (m)	7	7	7	7
	2"	2"+2 x1 1/2"	2"	3"
	50	50 +2x40	50	75
(h)	2	2	2	2
LWA dB(A)	104	104	104	104
mm	525 x420 x470	525 x 420 x470	525 x 420 x 470	580 x440 x445
Peso Poids Peso (Kg)	32	33	30	36
	✓	✓	✓	✓
	✓	✓	✓	✓
Aplicación Utilization Utilização	Aguas limpias Eaux claires Águas limpias	Aguas limpias Eaux claires Águas limpias	Aguas marinas/Abonos líquidos Eaux marines/Produits chimiques agricoles Águas marinas/Fertilizantes para a agricultura PH=4:PH=11	Aguas sucias Eaux lourdes Águas sujas
	-	-	-	25 mm
Código Code Código	5885	7265	5895	5890

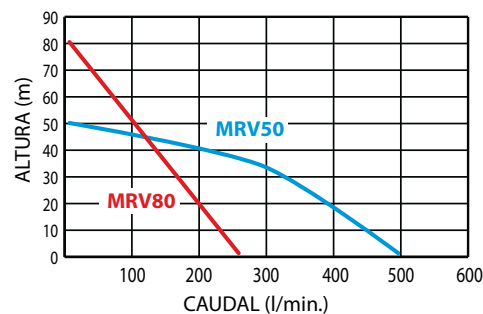
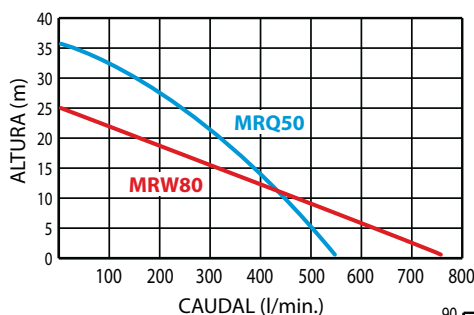

- Presión, aguas sucias, marinas y abonos líquidos
- Pression, eaux lourdes, marines et produits chimiques agricoles
- Pressão, águas sujas, marinas e fertilizantes para a agricultura

MOTOBOMBAS GASOLINA 4T - Presión, aguas sucias, marinas y abonos líquidos • MOTOPOMPES ESSENCE 4T - Pression, eaux lourdes, marines et produits chimiques agricoles • MOTOBOMBAS GASOLINA 4T - Pressão, águas sujas, marinas e fertilizantes para a agricultura

# MOTOBOMBAS GASOLINA 4 TIEMPOS

MOTOPOMPES ESSENCE 4 TEMPS

MOTOBOMBAS GASOLINA 4 TEMPOS

MADE IN JAPAN

**KOSHIN**

## SEH-25L



## SEH-25L KIT



## SEH-40H



GARDENING



IRRIGATION



SPRINKLER



WASHING



ENVIRONMENT

	SEH-25L	SEH-25L KIT	SEH-40H
Motor <i>Moteur</i> Motor	HONDA GX-25	HONDA GX-25	HONDA GXH-50
cm <sup>3</sup>	25/4T	25/4T	49/4T
KW	0,72	0,72	1,6
máx (l/h)	6.900	6.900	17.000
máx (m)	32	32	43
ASP. máx (m)	8	8	8
GAS	1"	1"	1 1/2"
mm	25	25	40
(h)	1	1	1
LWA dB(A)	104	104	106
mm	398x300x355	398x300x355 + 380x290x190	390x316x458
Peso <i>Poids</i> Peso (Kg)	7	11	11,5
	✓	✓	✓
	NO	5 m	NO
	NO	12 m	NO
AUTO ASPIRANTE	✓	✓	✓
AUTO AMOR-CANTE			
AUTO ASPIRANTE			
Código <i>Code</i> Código	8615	8615K	8643

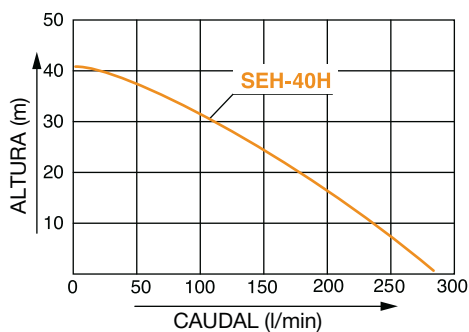
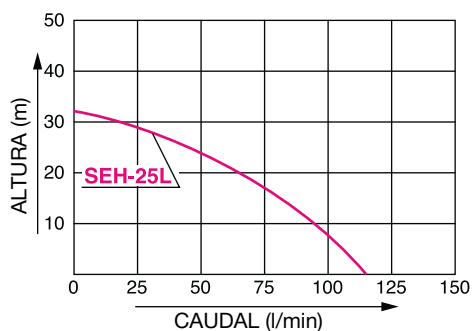

# MOTOBOMBAS GASOLINA 4 TIEMPOS

## MOTOPOMPES ESSENCE 4 TEMPS

### MOTOBOMBAS GASOLINA 4 TEMPOS

MADE IN JAPAN

**KOSHIN**

**SEH-50X**



ALERT OIL

**SEH-80X**



ALERT OIL

**SEH-100X**



ALERT OIL

	SEH-50X	SEH-80X	SEH-100X
Motor Moteur Motor	HONDA GX-120	HONDA GX-160	HONDA GX240
cm <sup>3</sup>	118/4T	163/4T	270/4T
KW	2,6	3,6	5,9
máx (l/h)	36.000	56.000	87.000
máx (m)	30	26	28
ASP. máx (m)	8	8	8
GAS	2"	3"	4"
mm	50	80	100
(h)	2	2	2
LWA dB(A)	103	105	113
mm	493x377x415	530x399x473	670x477x669
Peso Poids Peso (Kg)	24	34	59
	✓	✓	✓
AUTO ASPI-RANTE  AUTO AMOR-CANTE  AUTO ASPI-RANTE	✓	✓	✓
Código Code Código	<b>8617</b>	<b>8618</b>	<b>8754</b>



GARDENING



IRRIGATION



SPRINKLER



WASHING



ENVIRONMENT

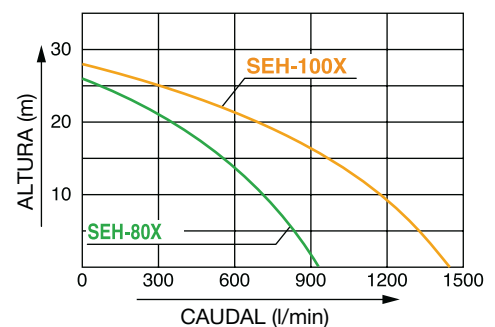
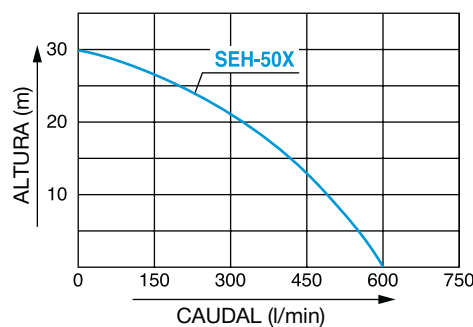

# MOTOBOMBAS GASOLINA 4 TIEMPOS

## MOTOPOMPES ESSENCE 4 TEMPS

### MOTOBOMBAS GASOLINA 4 TEMPOS

MADE IN JAPAN

**KOSHIN**

**SERH-50B**



ALERT OIL



**SERH-50V**



ALERT OIL



**SERH-50Z**



ALERT OIL



	SERH-50B	SERH-50V	SERH-50Z
Motor Moteur Motor	HONDA GX-160 4T High-Revolution	HONDA GX-160 4T High-Revolution	HONDA GX-200 4T High-Revolution
cm <sup>2</sup>	163	163	196
KW	3,6	3,6	4,3
máx (l/h)	26.400	25.800	30.000
máx (m)	57	80	90
ASP. máx (m)	8	8	8
GAS	2"	2"+2"x1"	2"+2"x1"
mm	50	50+2x25	50+2x25
(h)	2	2	2
LWA dB(A)	111	104	104
mm	535X405X440	555x450x468	570x450x468
Peso Poids Peso (Kg)	34	37	37,6
	✓	✓	✓
	✓	✓	✓
Código Code Código	<b>8873</b>	<b>8865</b>	<b>8874</b>

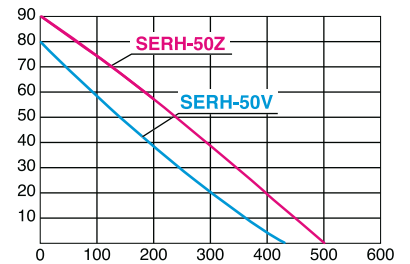
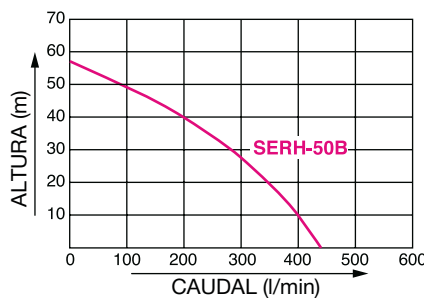

(\*) ACCESORIOS OPCIONALES ACCESSOIRES OPTIONNELS ACESÓRIOS OPCIONAIS

Kit manguera anti-incendios / Kit tuyau anti-incendie / Kit mangueira anti-incendios

Código Code Código	mm	mm	mm
32449	45	15 m	
32452	H 1"1/2	45 mm	
32454	H 2"	45 mm	
32203	M 1"1/2	45 mm	

# MOTOBOMBAS GASOLINA 4 TIEMPOS

## MOTOPOMPES ESSENCE 4 TEMPS









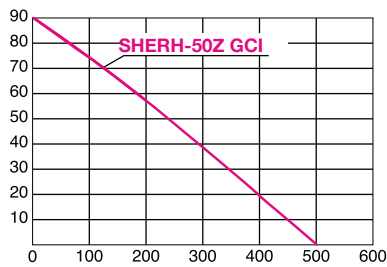





### MOTOBOMBAS GASOLINA 4 TEMPOS

MADE IN JAPAN

**KOSHIN**

ALERT OIL



	SERH-50Z GCI
Motor Moteur Motor	HONDA GX-200 4T High-Revolution
 cm <sup>3</sup>	196
 KW	4,3
 máx (l/h)	30.000
 máx (m)	90
ASP. máx (m)	8
 GAS	2" + 2" x 1"
 mm	50+2x25
 (h)	2
<b>LWA</b> dB(A)	104
 mm	570x450x468
Peso Poids Peso (Kg)	57,6
	✓
 AUTO ASPIRANTE  AUTO AMORCANTE  AUTO CASPIRANTE	✓
	7
	15
Código Code Código	<b>8874GCI</b>

CONTRA INCENDIOS • ANTI-INCENDIE • CONTRA INCENDIOS

# MOTOBOMBAS GASOLINA 4 TIEMPOS

## MOTOPOMPES ESSENCE 4 TEMPS

### MOTOBOMBAS GASOLINA 4 TEMPOS

MADE IN JAPAN

**KOSHIN**

**KTH80S**

ALERT OIL



**KTH100S**

ALERT OIL



**PGH50**

ALERT OIL

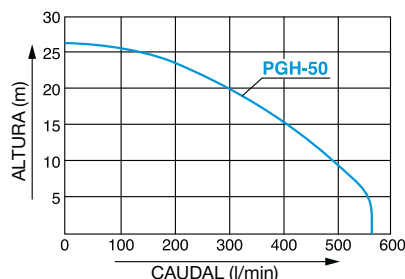
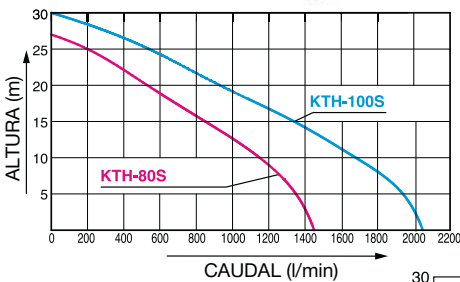

	KTH-80S	KTH-100S	PGH-50
	Aguas sucias Eaux lourdes		Aguas marinas Eaux marines Ph=4:Ph=11
Motor Moteur Motor	HONDA GX270 4T	HONDA GX390 4T	HONDA GX120 4T
cm <sup>3</sup>	270	389	118
KW	6,3	8,7	2,6
máx (l/h)	87.000	123.000	33.600
máx (m)	27	30	26
ASP. máx (m)	8	8	8
GAS	3"	4"	2"
mm	80	100	50
(h)	2	2	2
LWA dB(A)	105	106	106
mm	690x495x570	745x540x600	510x418x433
Peso Poids Peso (Kg)	65	82	22
	✓	✓	SOLO RÁCORES
AUTO ASPI-RANTE	✓	✓	✓
AUTO AMOR-CANTE			
AUTO ASPI-RANTE			
Ø máx.	27	30	✓
Código Code Código	<b>8760</b>	<b>9120</b>	<b>9125</b>

**KTH**



IRRIGATION



SHALLOW WELL



CONSTRUCTION



SILICON CARBIDE MECHANICAL SEAL

**PGH**



IRRIGATION



SHALLOW WELL



FISH FARM



SEA WATER



# MOTOBOMBAS DIESEL 4 TIEMPOS

## MOTOPOMPES DIESEL 4 TEMPS

### MOTOBOMBAS DIESEL 4 TEMPOS



	AZ-465	A-465	M-465	B-465
cm <sup>3</sup>	462	462	462	462
KW	7,5	7,5	7,5	7,5
	Eléctrico Électrique Elétrico			
máx (l/h)	13.000	44.000	66.000	110.000
máx (m)	110,5	60	40	35
ASP	1" 1/2	2"	2" 1/2	DN100-4
IMP	1" 1/4	1" 1/2	2" 1/2	DN100-4R
Aplicación Utilization Utilização	Alta presión Haute pression Alta pressão		Media presión Moyenne pression Pressão média	Baja presión Basse pression Pressão baixa
(h)	3	3	3	3
	4,7 L	4,7 L	4,7 L	4,7 L
LWA	103	103	103	103
	550 x 550 x 565 mm			
Peso Poids Peso (Kg)	61	62	65	68
Código Code Código	<b>8985</b>	<b>8986</b>	<b>8987</b>	<b>8988</b>
<b>ACCESORIOS • ACCESSOIRES • ACESÓRIOS</b>				
45 Ah	970003	970003	970003	970003

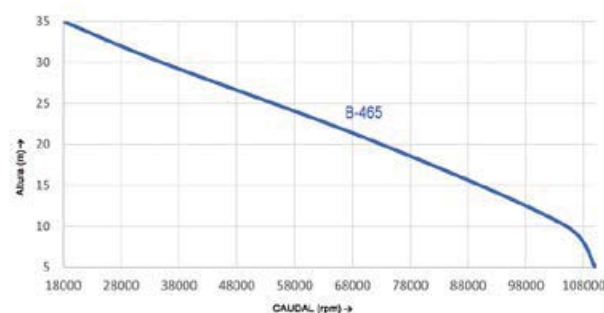
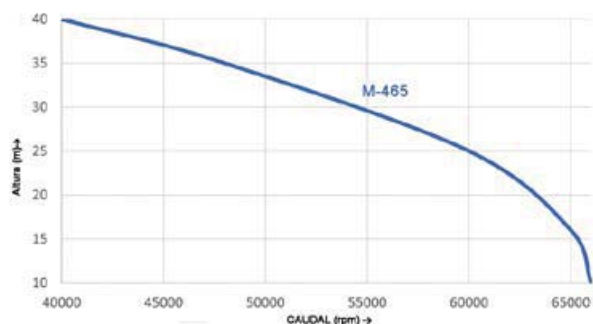
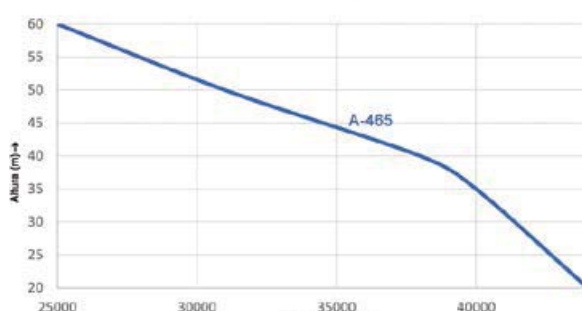
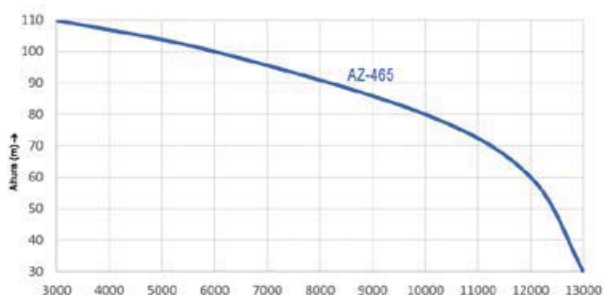

# ACCESORIOS "BLISTER"

## ACCESSOIRES "BLISTER"

### ACESÓRIOS "BLISTER"

#### CONJUNTO RACORES • KIT RACCORDS • CONJUNTO UNIÃO



Ref./Réf./Réf.	Mang. Ø Diam. Tuyau Mang. Ø
SK12784	25
SK13203	30
SK12785	35
SK12786	40
SK12787	50

#### RÁCOR MACHO • RACCOR MÂLE • UNIÃO MACHO



Ref./Réf./Réf.	Mang. Ø Diam. Tuyau Mang. Ø	Rosca gas Filetage Rosca gás
SK12101	25	1"
SK32213	30	1"
SK13159	35	1 1/4"
SK13160	40	1 1/4"
SK13639	40	1 1/2"
SK13161	50	1 1/2"

#### CONJUNTO RACORES • KIT RACCORDS • CONJUNTO UNIÃO



Ref./Réf./Réf.	Mang. Ø Diam. Tuyau Mang. Ø	Rosca gas Filetage Rosca gás
SK31611	25	1"
SK12434	30	1"
SK12843	35	1 1/2"
SK17165	40	1 1/4"
SK12791	40	1 1/2"
SK12792	50	1 1/2"

#### RÁCOR HEMBRA • RACCOR FEMELLE • UNIÃO FEMEA



Ref./Réf./Réf.	Mang. Ø Diam. Tuyau Mang. Ø	Rosca gas Filetage Rosca gás
SK11818	25	1"
SK32461	30	1 1/4"
SK32221	40	1 1/2"
SK11201	50	2"

#### CONJUNTO RACORES 90° • KIT RACCORDS 90° • CONJUNTO UNIÃO 90°



Ref./Réf./Réf.	Mang. Ø Diam. Tuyau Mang. Ø	Rosca gas Filetage Rosca gás
SK32243	25	1"
SK13205	30	1"
SK12844	35	1 1/2"
SK17166	40	1 1/4"
SK12797	40	1 1/2"
SK12798	50	1 1/2"

#### JUNTAS (2 unidades) • JOINTS • JUNTAS



Ref./Réf./Réf.	Mang. Ø Diam. Tuyau Mang. Ø	Rosca gas Filetage Rosca gás
SK11821	25	1"
SK13670	50	2"

#### CONJUNTO VÁLVULA DE PIE • KIT CLAPET • CONJUNTO VÁLVULA DE PÉ



Ref./Réf./Réf.	Mang. Ø Diam. Tuyau Mang. Ø	Rosca gas Filetage Rosca gás
SK13163	25	1"
SK13164	35	1 1/4"
SK13669	40	1 1/2"

#### MACHÓN • RACCOR DOUBLE • MÂLE MACHON



Ref./Réf./Réf.	Mang. Ø Diam. Tuyau Mang. Ø
SK31610	1 x 1"
SK32462	1" 1/4 x 1" 1/4
SK13635	1" 1/2 x 1" 1/2
SK32463	2 x 2"

#### VÁLVULA DE PIE LATÓN • CLAPET EN LAITON • VÁLVULA DE PÉ EM LATÃO



Ref./Réf./Réf.	Rosca gas Filetage Rosca gás
SK31533	1"
SK32192	1 1/4"
SK32193	1 1/2"

#### CARRETIILLAS MOTOBOMBAS • CHARIOT MOTOPOMPES • CARRO MOTOBOMBA



Ref./Réf./Réf.	Aplicación Application Aplicação
091089	H-60 / H-102
091099	H-165
091120	VARIAS

ACCESORIOS A GRANEL: CONSULTAR EL APARTADO DE ACCESORIOS EN PLÁSTICO. (PAG. 133)

ACCESSOIRES AU DÉTAIL: VEUILLEZ CONSULTER LA SECTION DES ACCESSOIRES EN PLASTIQUE. (PAGE. 133)

ACESÓRIOS A GRANEL: CONSULTAR O APARTADO DE ACESÓRIOS EM PLÁSTICO. (PAG. 133)

\* Suministrada con tornillería y sin taladrar para no limitar aplicaciones.

\* Fourni avec visserie et sans percer pour ne limiter pas les applications.

\* Suministrada com parafusos e sem perfurar para não limitar as aplicações.

# ELECTROBOMBAS

## ELECTROPOMPES

### BOMBAS ELÉCTRICAS

MADE IN JAPAN

**KOSHIN**

**PBX-55022**  
**PBX7-55022**



**PX-55022**



**PXL-52522**



	PBX-55022	PBX7-55022	PX-55022	PXL-52522
230V	680W	1250W	620 W	540W
máx (l/h)	18.600	19.800	15.600	7.200
máx (m)	9,5	15	10	10
	ø50mm(2")	ø50mm(2")	Ø 50 mm (2")	ø25mm(1")
	✓	✓	✓	✓
	40	40	40	1
	5	5	5	5
Ø máx.	6mm	6mm	6mm	1mm
Peso Poids Peso (Kg)	15	15,5	11	12
	271 X 280 X 524	271 X 280 X 524	308 X 181 X 181	315 X 191 X 224
	✓	✓	✓	✓
	Opcional - Optionnel - Opcional <sup>(1)</sup>		-	-
	10m	10m	10m	10m
Código Code Código	<b>9127</b>	<b>9128</b>	<b>5053</b>	<b>5055</b>

Altura/Caudal • Hauteur/Débit • Altura/Caudal

Modelo/ Modèle/ Modelo	Q (m³/h) (l/min)	0	1,5	3	4,5	6	7,5	9	12	15	16,5	18	19,5
		0	25	50	75	100	125	150	200	250	275	300	325
PBX		9,5	8,8	8,2	7,3	6,5	5,6	4,7	4	2,1	1,5	1	
PBX7	H (m)	15	13,8	12,7	11,4	10,2	9,1	8	6	3,9	3	1,5	1
PX		10	9,5	9	8,3	7,5	6,6	5,5	3,5	1			
PXL		10	9,2	7,5	5,8	3							

(\*) **ACCESORIOS OPCIONALES**  
ACCESSOIRES OPTIONNELS • ACESÓRIOS OPCIONAIS

**PBX/PBX7**

Código Code Código **9129**



PX - PXL

GAMA KOSHIN-ACHIQUE uso Profesional • GAMME KOSHIN-VIDECAVE pour utilization Professionnelle • GAMMA KOSHIN-ACHIQUE uso Profissional

*Campeon*

# ELECTROBOMBAS

## ELECTROPOMPES

### BOMBAS ELÉCTRICAS

MADE IN JAPAN

**KOSHIN**

PXJ-150

**NEW**



PXJ-250/400/750

**NEW**



	PXJ-150	PXJ-250	PXJ-400	PXJ-750
230V	150W	250W	400W	750W
máx (l/h)	5.700	11.400	11.700	19.500
máx (m)	6	8,5	10,5	14
	15/20/25 mm (1")	40 mm (1 1/2")	50 mm (2")	50 mm (2")
	3	55	51	44
	7	7	7	7
Ø máx.	-	6mm	6mm	6mm
Peso Poids Peso (Kg)	3,5	11	12	17
	138x138x280	167x167x370	167x167x370	192x192x430
	✓	✓	✓	✓
FLUIDO FLUIDO FLUIDE	Aguas sucias exentas de sólidos en suspensión Eaux usées sans matières en suspension Águas sujas livres de sólidos suspensos		Aguas sucias medianamente cargadas Eaux usées moyennement chargée Águas sujas moderadamente carregadas	
	10m	10m	10m	10m
Código Code Código	<b>9449</b>	<b>9450</b>	<b>9451</b>	<b>9452</b>

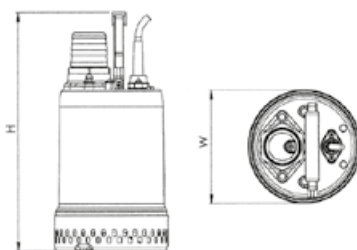

Modelo	H	W
PXJ-150	280	138
PXJ-250	370	167
PXJ-400	370	167
PXJ-750	430	192

Altura/Caudal • Hauteur/Débit • Altura/Caudal

Modelo/Modèle/Modelo	Q (m³/h) (l/min)	0	3	5,4	8.1	10,8	13,5	16,2	18
		0	50	90	135	180	225	270	300
PXJ-150	H (m)	6	3,7	0,5					
PXJ-250		8,5	7,3	6,3	4,3	1			
PXJ-400		10,5	9,2	7,8	5,8	2			
PXJ-750		14	13	12,2	11	9,5	7,5	5,5	2

# ELECTROBOMBAS

## ELECTROPOMPES

### BOMBAS ELÉCTRICAS

MADE IN JAPAN

**KOSHIN**

PKJ-150/250/400/700/1500

**NEW**

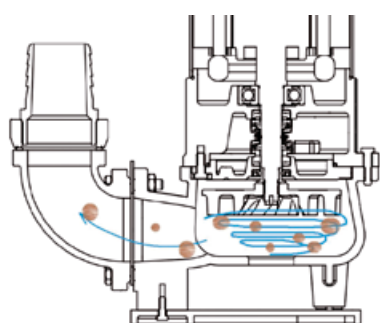

	PKJ-150	PKJ-250	PKJ-400	PKJ-750	PKJ-1500
230V	150W	250W	400W	750W	1500W
máx (l/h)	9.000	13.500	14.700	20.400	40.800
máx (m)	6	6	7	11	11
	32mm (1 1/4")	40mm (1 1/2")	50mm (2")	50mm (2")	80mm (3")
	93	126	123	123	195
	7	7	7	7	7
Ø máx.	10mm	30mm	30mm	30mm	30mm
Peso Poids Peso (Kg)	4,5	12,5	13	18	34,5
FLUIDO FLUIDO FLUIDE	Aguas sucias exentas de sólidos en suspensión Eaux usées sans matières en suspension Águas sujas livres de sólidos suspensos		Aguas sucias medianamente cargadas Eaux usées moyennement chargée Águas sujas moderadamente carregadas		
	198x135x327	215x145x395	215x145x410	228x153x430	395x195x600
	✓	✓	✓	✓	✓
	10m	10m	10m	10m	10m
Código Code Código	<b>9453</b>	<b>9455</b>	<b>9459</b>	<b>9460</b>	<b>9438</b>

Altura/Caudal • Hauteur/Débit • Altura/Caudal

Modelo/ Modèle/ Modelo	Q (m <sup>3</sup> /h) (l/min)	0	3	6	9	12	16,5	21	25,5	30	34,5	39
		0	50	100	150	200	275	350	425	500	575	650
PKJ-150	H (m)	6	4,6	2,9	0,2							
PKJ-250		6	5,1	3,2	3	1,2						
PKJ-400		7	6,1	5,3	4,1	2,6						
PKJ-750		11	10	9,1	8	6,9	4					
PKJ-1500		11	10,5	10	9,5	9	8,2	7	4,8	4,3	2,6	0,8

# ELECTROBOMBAS

## ELECTROPOMPES

### BOMBAS ELÉCTRICAS

MADE IN JAPAN

**KOSHIN**

PKG-750 / 1200 / 1500

**NEW**



	PKG-750	PKG-1200	PKG-1500
230V	750W	1.200W	1.500W
máx (l/h)	10.500	10.800	10.800
máx (m)	13	18	20,5
	32mm (1 1/4")	32mm (1 1/4")	32mm (1 1/4")
	160	160	160
	7	7	7
Ø máx.	3mm	3mm	3mm
Peso Poids Peso (Kg)	27	29	34,5
mm	300X170X557	300X170X557	305X180X605
FLUIDO FLUIDO FLUIDE	AGUAS SUCIAS Y CARGADAS CON FIBRAS LARGAS EAUX USÉES ET CHARGÉE DE FIBRES LONGUES ÁGUAS SUJAS E CARREGADAS COM FIBRAS LONGAS		
	✓	✓	✓
	10m	10m	10m
Código Code Código	<b>9437</b>	<b>9417</b>	<b>9396</b>



Altura/Caudal • Hauteur/Débit • Altura/Caudal

Modelo/ Modèle/ Modelo	Q (m³/h) (l/min)	0	2,4	4,8	7,2	9,6
PKG-750		13	11,5	9,5	6,4	2
PKG-1200	H (m)	18	15,9	13,4	9,6	3,5
PKG-1500		20,5	18,4	15,8	12	5

# ELECTROBOMBAS

## ELECTROPOMPES

### BOMBAS ELÉCTRICAS

**iWAT-200**



**iPLU-400**



**iFLO**



	<b>iWAT-200</b>	<b>iPLU-400</b>	<b>iFLO-300</b>	<b>iFLO-600</b>
230V	220W	440W	300W	600W
máx (l/h)	5.700	8.400	7.500	11.700
máx (m)	5,5	7	6,5	9
	1 1/4"	1 1/4"	1 1/2"	1 1/2"
	25-30	30	25-40	25-40
	2-3	10	MANUAL 2-3mm AUTOMATIC 45mm	
Ø máx.	5mm	10/30mm	5mm	5mm
Peso Poids Peso (Kg)	3,75	4,67	4,50	5,20
	221X167X315	221X167X315	240X200X340	240X200X340
	✓	✓	✓	✓
	✓	✓	✓	✓
	10m	10m	10m	10m
Código Code Código	<b>9613</b>	<b>9614</b>	<b>9615</b>	<b>9616</b>

**Altura/Caudal • Hauteur/Débit • Altura/Caudal**

Modelo/ Modèle/ Modelo	Q (m <sup>3</sup> /h) (l/min)	0	1,2	2,4	3,6	4,8	6	7,2	8,4	9,6	10,8
		0	20	40	60	80	100	120	140	160	180
<b>iWAT-200</b>	H (m)	<b>5,5</b>	<b>4,8</b>	<b>4</b>	<b>3,3</b>	<b>2,3</b>	<b>1</b>				
<b>iPLU-400</b>		<b>7</b>	<b>6,5</b>	<b>6</b>	<b>5,5</b>	<b>4,5</b>	<b>4</b>	<b>3</b>	<b>2</b>		
<b>iFLO-300</b>		<b>6,5</b>	<b>6,1</b>	<b>5,5</b>	<b>5</b>	<b>4</b>	<b>2,8</b>	<b>0,8</b>			
<b>iFLO-600</b>		<b>9</b>	<b>8,7</b>	<b>8,2</b>	<b>7,7</b>	<b>7,1</b>	<b>6,6</b>	<b>5,9</b>	<b>4,9</b>	<b>3,3</b>	<b>1,8</b>



ACHIQUE AGUAS CLARAS/SUCIAS • VIDECAVE EAUX CLAIRES/TRÈS CHARGÉES ACHIQUE • ÁGUAS LIMPAS/SUJAS

# ELECTROBOMBAS

## ELECTROPOMPES

### BOMBAS ELÉCTRICAS

#### iDIVER 1000A



	iDIVER-750A	iDIVER-1000A	iDIVER-1200A
230V	750W	900W	1100W
máx (l/h)	5.700	5.700	5.700
máx (m)	24	36	48
	1"	1"	1"
	25/19-1"3/4"	25/19-1"3/4"	25/19-1"3/4"
	12	12	12
	2	3	4
Peso Poids Peso (Kg)	7,50	8,75	9,2
	240 X 200 X 470	240 X 200 X 470	240 X 200 X 470
	✓	✓	✓
	✓	✓	✓
	15m	15m	15m
	15m	15m	15m
Ø mm	150	150	150
Código Code Código	<b>9642</b>	<b>9639</b>	<b>9640</b>

**Válvula antiretorno incorporada**  
**Clapet anti retour incorporé**  
**Válvula antiretorno incorporada**

#### Altura/Caudal • Hauteur/Débit • Altura/Caudal

Modelo/ Modèle/ Modelo	Q (m <sup>3</sup> /h) (l/min)	0	0,6	1,2	1,8	2,4	3	3,6	4,2	4,8	5,4	5,7
		0	10	20	30	40	50	60	70	80	90	95
<b>iDIVER-750A</b>	H (m)	24	23	22	21	19	16	14	10	6	2	
<b>iDIVER-1000A</b>		36	34	32	29	27	23	19	15	10	4	
<b>iDIVER-1200A</b>		48	45	42	38	35	30	25	20	13	5	1

SUMERGIBLES 5" AGUAS CLARAS • IMMERGÉES POUR PUIITS 5" • SUBMERSÍVEL 5" ÁGUAS LIMPAS



# ELECTROBOMBAS

## ELECTROPOMPES

### BOMBAS ELÉCTRICAS

iDEP 1200

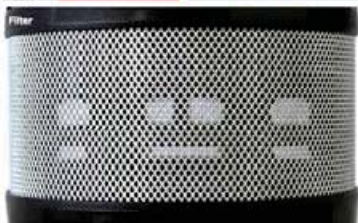

iDEP-1200

230V	1100W
máx (l/h)	5.700
máx (m)	46
	1"
	25/19-1"3/4"
	12
	4
Peso Poids Peso (Kg)	10,8
	200X250X575
	√
	15m
	15m
Ø mm	150
Código Code Código	9617

Válvula antiretorno incorporada  
Clapet anti retour incorporé  
Válvula antiretorno incorporada

Altura/Caudal • Hauteur/Débit • Altura/Caudal

Modelo/ Modèle/ Modelo	Q (m³/h) (l/min)	0	0,6	1,2	1,8	2,4	3	3,6	4,2	4,8	5,4	5,7
		0	10	20	30	40	50	60	70	80	90	95
iDEP-1200	H (m)	46	44	42	38	35	30	25	20	13	5	1

SUMERGIBLES AGUAS CLARAS A PRESIÓN CONSTANTE • IMMERGÉES POUR PUIITS-SYSTÈME DE CONTRÔLE COMPUTERISÉ SUBMERGIBLE • ÁGUAS LIMPAS E PRESSÃO CONSTANTE

# ELECTROBOMBAS

## ELECTROPOMPES

### BOMBAS ELÉCTRICAS

#### SONDY



	SONDY-75	SONDY-100	SONDY-150	SONDY-200
230V	550W	750W	1100W	1500W
máx (l/h)	7.800	7.800	7.800	7.800
máx (m)	32	43	65	75
	1 1/4"	1 1/4"	1 1/4"	1 1/4"
g/m <sup>3</sup>	40 máx.	40 máx.	40 máx.	40 máx.
min mm	20	20	20	20
	3	4	6	8
Peso Poids Peso (Kg)	13,5	14,5	16	18,5
	494X230X140	540X230X140	630X230X140	686X230X140
Ø máx.	2mm	2 mm	2mm	2mm
	-	-	-	-
	✓	✓	✓	✓
	20m	20m	20m	20m
	20m	20m	20m	20m
Código Code Código	<b>9461</b>	<b>9462</b>	<b>9463</b>	<b>9464</b>

#### VALVULA ANTI-RETORNO NO INCLUIDA

Se aconseja instalar válvula de retención en la salida de la bomba para evitar el vaciado de la tubería y posibles golpes de ariete

Código : 201746 + Código 74429

#### CLAPET ANTI-RETOUR NON INCLUSE

Il est conseillé d'installer un clapet anti-retour dans la sortie de la pompe pour éviter de vider le tuyau et les coups de bélier

Code : 201746 + Code 74429

#### VÁLVULA ANTI-RETORNO NÃO INCLUIDA

É aconselhável instalar a válvula de retenção saída da bomba para evitar esvaziar o tubo e possível golpe de ariete

Código: 201746 + Code 74429

#### Dimensiones • Dimensions • Dimensões

	Ø (mm)	H (mm)	DNM
SONDY-75	126	464	1 1/4"
SONDY-100	126	510	1 1/4"
SONDY-150	126	600	1 1/4"
SONDY-200	126	656	1 1/4"

#### Altura/Caudal • Hauteur/Débit • Altura/Caudal

Modelo/ Modèle/ Modelo	Q (m <sup>3</sup> /h) (l/min)	0	2	3	3,5	4	4,5	5	5,5	6	7,8
			0	33	55	58	67	75	83	92	100
SONDY-75	H (m)	32	28	27	25	23	21	19	15	13	4
		43	38	36	34	31	28	25	19	17	6
		65	56	54	51	47	42	37	28	26	10
		75	66	63	59	54	49	44	37	30	13

SUMERGIBLES 5" AGUAS CLARAS • IMMERGÉES POUR PUITS 5" • SUBMERSÍVEL 5" ÁGUAS LIMPAS

# ELECTROBOMBAS

## ELECTROPOMPES

### BOMBAS ELÉCTRICAS

**iTIP-1000**

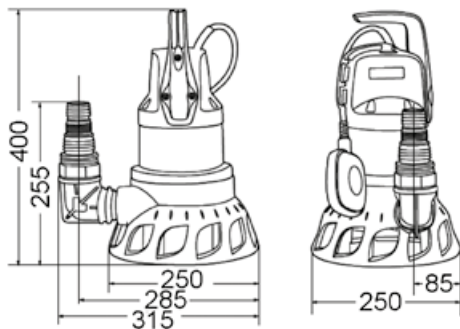

medidas en mm

	<b>iTIP-1000</b>
230V	1000W
máx (l/h)	19.200
máx (m)	11
	1 1/2"
	50-1 1/2"-40
	50/40-1 1/4"
	7
Peso Poids Peso (Kg)	8
	260X260X430
	✓
	✓
Ø máx.	38mm
	10m
Código Code Código	<b>9619</b>

**Altura/Caudal • Hauteur/Débit • Altura/Caudal**

Modelo/ Modèle/ Modelo	Q (m <sup>3</sup> /h) (l/min)	0	2,4	4,8	7,2	9,6	12	14,4	16,8	19,2
		0	40	80	120	160	200	240	280	320
<b>iTIP-1000</b>	H (m)	<b>11</b>	<b>10,2</b>	<b>9,4</b>	<b>8,4</b>	<b>7,2</b>	<b>6</b>	<b>4,9</b>	<b>3,2</b>	<b>1</b>

**(\*) ACCESORIOS OPCIONALES**

ACCESSOIRES OPTIONNELS • ACESÓRIOS OPCIONAIS

**S.O.S KIT INUNDACIONES**

Código Code Código **9671**

10 m

Peso Poids Peso 6,25 Kg



**No incluye bomba / Ne compreno pas de pompe / Não inclui bomba**

ACHIQUE AGUAS RESIDUALES • VIDECAVE EAUS TRÈS CHARGÉES • ACHIQUE ÁGUAS RESIDUAIS

# ELECTROBOMBAS

## ELECTROPOMPES

### BOMBAS ELÉCTRICAS

#### ijET-900 / 1200



#### iPRO-1200



	ijET-900	ijET-1200	iPRO-1200
230V	850W	1100W	1100W
máx (l/h)	3.180	3.750	3.750
máx (m)	43	45	45
	1"	1"	1"
mm	25	25	25
ASP. máx. (m)	8	8	8
	-	-	✓
Peso Poids Peso (Kg)	9,06	9,84	10,34
mm	540X250X380	540X250X380	540X250X380
	✓	✓	✓
	✓	✓	✓
	✓	✓	✓
	1,5m	1,5m	1,5m
	✓	✓	✓
Código Code Código	9602	9604	9609

#### K-7



Kit de aspiración 7m  
Kit d'aspiration 7m  
Kit de aspiração 7m

Código Code Código **33520**

mm	25
	7m
	1" H/M
	✓

#### Altura/Caudal • Hauteur/Débit • Altura/Caudal

Modelo/ Modèle/ Modelo	Q (m³/h) (l/min)	0	0,6	1,2	1,8	2,4	3	3,6
ijET-900	H (m)	43	34	29	24	19	5	
ijET-1200		45	38	34	29	24	17	2
iPRO-1200		45	38	34	29	24	17	2

# ELECTROBOMBAS

## ELECTROPOMPES

### BOMBAS ELÉCTRICAS

iSEN-1200



**(\*) 5 AÑOS LIBRE MANTENIMIENTO**  
**5 ANS SANS BESOIN D'ENTRETIEN**  
**5 ANOS LIVRE DE MANUTENÇÃO**



#### (\*) ACCESORIOS OPCIONALES

ACCESSOIRES OPTIONNELS • ACESÓRIOS OPCIONAIS

TANK KIT		Membrana fija Membrane fixe Membrana fixa
GLOBAL WATER	18L	
Código Code Código	9670	

	iSEN-1200
230V	1100W
máx (l/h)	3.750
máx (m)	45
	1"
mm	25
ASP. máx (m)	8
Bar	1,8/3,2
Peso Poids Peso (Kg)	15,3
mm	540x300x620
	✓
	✓
	1,5m
	✓
	✓
	18l <small>Global Water-Membrana fija Membrane fixe Membrana fixa</small>
Código Code Código	9612

#### Altura/Caudal • Hauteur/Débit • Altura/Caudal

Modelo/ Modèle/ Modelo	Q (m³/h) (l/min)	0	0,6	1,2	1,8	2,4	3	3,6
iSEN-1200	H (m)	45	38	34	29	24	17	2

# ELECTROBOMBAS

## ELECTROPOMPES

### BOMBAS ELÉCTRICAS



**NEW**

#### ACCESORIOS

Se suministra con interruptor, cable de 1,5 m y conector.

#### FUNCIONAMIENTO

Fluido: Agua limpia  
 Temperatura máxima del líquido: 60°C  
 Presión máxima de ejercicio: 5 bar  
 Altura máxima de aspiración: 6 m  
 Caudal máximo: 7,2 m<sup>3</sup>/h

Modelo	Código
<b>HIDROBOX 1000</b>	204200

#### Diseño compacto



#### Pantalla táctil LCD



#### Muy silencioso LwA 60 dB(A)



#### Gran rendimiento hidráulico



Max. Caudal **7.2** m<sup>3</sup>/h  
 Max. Presión **50** m

# ELECTROBOMBAS

## ELECTROPOMPES

### BOMBAS ELÉCTRICAS

**Arranque /paro automáticos, detección de anomalías. Protección contra sobretemperatura, heladas y pérdidas de agua.**



**Motor sincro de imanes permanentes**

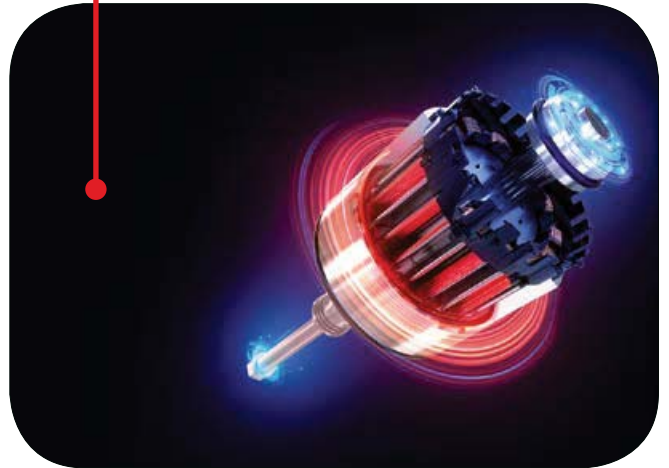

**Presión constante por acción del variador de frecuencia**

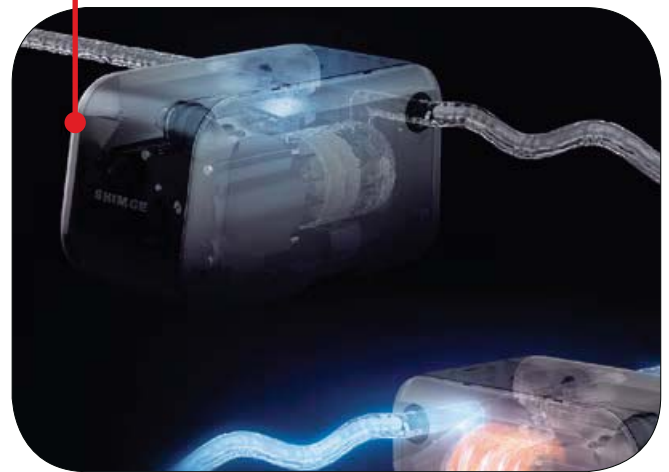

**Prestaciones**

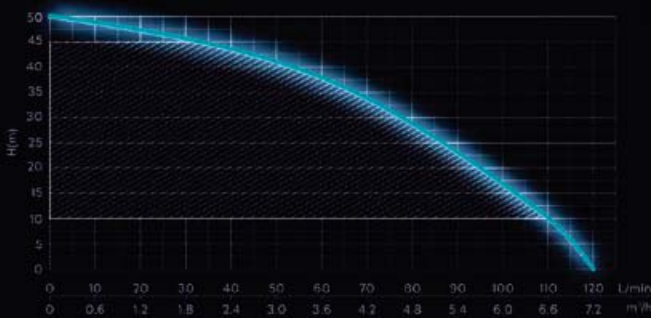

Modelo	Potencia P2		Max. Caudal	Max. Presión	Rango Presión	Max Aspiración	Rpm	H8	V monofásico	A	Peso	Dimensiones
	kW	HP										
<b>HIDROBOX 1000</b>	1.00	1.35	7.2	50	10-45	6	2500-5200	50-60	220-240	8	11.5	455*345*315

# ELECTROBOMBAS

## ELECTROPOMPES

### BOMBAS ELÉCTRICAS

#### BEM/ROVER

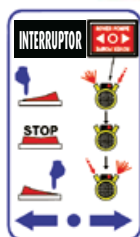

Aplicación Utilization Utilização	TRASIEGO • TRANSFERT • TRASFEGA									
Modelo Modèle Modelo	BEM-10	ROVER-20	ROVER-25	ROVER-30	BEM-20	BEM-25	BEM-30	BEM-40	BEM-50	
IP	IP-X4	IP-X4	IP-X4	IP-X4	IP-55	IP-X4	IP-X4	IP-X4	IP-X4	
Código Code Código	BEM10	BEM20	ROV25	ROV30	BEM21	BEM25	BEM30	BEM40	BEM50	
230V	0,4CV	0,5CV	0,8CV	1CV	0,5CV	0,6CV	1CV	1,2CV	3CV	
☑ máx (l/h)	420	1.700	2.500	4.500	1.700	2.400	5.000	6.500	15.000	
🕒 máx (m)	10	25	25	20	25	12	15	15	25	
🔄	2850	2850	2850	2850	2850	1450	1450	1450	1450	
🔧	10mm	20mm	25mm	30mm	20mm	25mm	30mm	40mm	50mm	

#### Altura/Caudal • Hauteur/Débit • Altura/Caudal

Modelo/Modèle/Modelo	Q (m³/h) (l/min)	0	0,3	0,6	0,9	1,2	1,5	2,1	2,7	3,6	4,8	6	7,7	9,0	10,8	13,2
		0	5	10	15	20	25	35	45	60	80	100	120	150	180	200
<b>BEM-10</b>	H (m)	<b>10</b>	<b>3</b>		<b>29</b>	<b>24</b>	<b>17</b>									
<b>ROVER-20/BEM-20</b>		<b>25</b>	<b>18</b>	<b>16</b>	<b>12</b>	<b>7</b>	<b>3</b>									
<b>ROVER-25</b>		<b>25</b>	<b>23</b>	<b>20</b>	<b>16</b>	<b>13</b>	<b>9</b>	<b>3</b>								
<b>ROVER-30</b>		<b>20</b>	<b>17</b>	<b>14</b>	<b>12</b>	<b>10,5</b>	<b>9</b>	<b>8,5</b>	<b>7</b>	<b>5</b>	<b>3</b>					
<b>BEM-25</b>		<b>12</b>	<b>10</b>	<b>9</b>	<b>7,5</b>	<b>6</b>	<b>5,5</b>	<b>1,5</b>								
<b>BEM-30</b>		<b>15</b>	<b>11</b>	<b>11</b>	<b>10</b>	<b>9,5</b>	<b>9</b>	<b>8</b>	<b>5</b>	<b>3</b>	<b>0,5</b>					
<b>BEM-40</b>		<b>15</b>	<b>11</b>	<b>11</b>	<b>10,5</b>	<b>10</b>	<b>9,5</b>	<b>8,5</b>	<b>7</b>	<b>5</b>	<b>3</b>	<b>1</b>				
<b>BEM-50</b>		<b>25</b>	<b>24</b>	<b>24</b>	<b>23,5</b>	<b>23</b>	<b>22</b>	<b>21</b>	<b>21</b>	<b>19</b>	<b>17</b>	<b>14</b>	<b>12</b>	<b>9</b>	<b>7</b>	<b>3</b>

#### NOVAX



Aplicación Utilization Utilização	TRASIEGO • TRANSFERT • TRASFEGA													
Modelo Modèle Modelo	NOVAX-20	NOVAX-20B	NOVAX-25	NOVAX-30	NOVAX-40	NOVAX-50								
IP	IP-X4	IP-X4	IP-X4	IP-X4	IP-X4	IP-X4								
Código Code Código	NOVAX20	NOVAX20B	NOVAX25	NOVAX30	NOVAX40	NOVAX50								
230V	0,5CV	0,5CV	0,6CV	1CV	1,2CV	3CV								
☑ máx (l/h)	1.700	1.700	2.400	5.000	6.500	15.000								
🕒 máx (m)	25	20	12	15	15	25								
🔄	2850	2850	1450	1450	1450	1450								
🔧	20mm	20mm	25mm	30mm	40mm	50mm								
🔥 máx	40°C	95°C	40°C	40°C	40°C	40°C								

#### Altura/Caudal • Hauteur/Débit • Altura/Caudal

Modelo/Modèle/Modelo	Q (m³/h) (l/min)	0	0,6	0,9	1,2	1,5	2,1	2,7	3,6	4,8	6,0	7,2	9,0	10,8	13,2
		0	10	15	20	25	35	45	60	80	100	120	150	180	220
<b>NOVAX-20</b>	H (m)	<b>25</b>	<b>16</b>	<b>12</b>	<b>7</b>	<b>3</b>									
<b>NOVAX-25</b>		<b>12</b>	<b>12</b>	<b>10,5</b>	<b>8,5</b>	<b>6,5</b>	<b>2</b>								
<b>NOVAX-30</b>		<b>15</b>	<b>13</b>	<b>12</b>	<b>11</b>	<b>10,5</b>	<b>8,5</b>	<b>7</b>	<b>4</b>	<b>1</b>					
<b>NOVAX-40</b>		<b>15</b>	<b>14</b>	<b>13</b>	<b>12</b>	<b>11,5</b>	<b>10</b>	<b>9</b>	<b>7</b>	<b>4</b>	<b>1</b>				
<b>NOVAX-50</b>		<b>25</b>	<b>24</b>	<b>23,5</b>	<b>23</b>	<b>22</b>	<b>21</b>	<b>20</b>	<b>19</b>	<b>17</b>	<b>14</b>	<b>12</b>	<b>9</b>	<b>7</b>	<b>3</b>

#### DRILL



Aplicación Utilization Utilização	TRASIEGO • TRANSFERT • TRASFEGA		
Modelo Modèle Modelo	DRILL-14	DRILL-20	DRILL-25
Código Code Código	DRILL14	DRILL20	DRILL25
☑ máx (l/h)	1.400	1.500	2.500
🕒 máx (m)	24	24	24
🔄	2850	2850	2850
🔧	14mm	20mm	25mm





# ELECTROBOMBAS

## ELECTROPOMPES

### BOMBAS ELÉCTRICAS

**iMATIC**



	<b>iMATIC</b>
230V	<1500W
máx (l/h)	<10.000
máx (m)	<10 bar
min (m)	>1,5 bar
Arranque/Démarrage/ Arranque	1,5-2,8 bar Regulable/Réglable/Ajustável
Peso Poids Peso (Kg)	1,3
mm	130X140x250
	60°
	1"
	✓
Código Code Código	<b>9188</b>

El sistema iMATIC, de fácil instalación, automatiza cualquier bomba de superficie o sumergida sin necesidad de utilizar vaso de expansión.

El iMATIC detecta la apertura de un grifo o electroválvula poniendo en marcha la electrobomba a caudal constante.

Válvula antiretorno incorporada.

Le iMATIC est le système de contrôle électronique qui sert à automatiser le fonctionnement de la pompe.

Il détecte la perte de pression à l'ouverture d'un robinet, électrovanne, où n'importe quel dispositif, et démarre automatiquement la pompe, jusqu'à l'arrêt du flux d'eau par de la fermeture du robinet ou dispositif.

Il protège aussi la pompe contre le fonctionnement à sec. De très facile installation. Il faut uniquement le raccorder sur la sortie de la pompe et brancher la prise de la pompe.

Il est muni d'un clapet antiretour.

O sistema iMATIC, de fácil instalação, automatiza qualquer eletrobomba de superfície ou submersível sem necessidade de utilizar autoclave.

O iMATIC deteta a abertura de uma torneira ou eletroválvula pondo em andamento a eletrobomba a caudal constante.

Válvula de anti-retorno incorporada.

**(\*) ACCESORIOS OPCIONALES • ACCESSOIRES OPTIONNELS • ACESÓRIOS OPCIONAIS**

**ENLACE M-H 3 piezas roscado /  
RACCORD M-H 3 pièces filetées / RACORD M-H 3 peças roscadas**

Código Code Código	203481	203754
	1"	1"1/4



# JARDÍN JARDIN JARDIN

MADE IN JAPAN

**KOSHIN**

GAMA KOSHIN-PULVERIZADORES DE PRESION PREVIA • GAMME KOSHIN PULVERISATEURS PRESSION PRÉALABE • GAMA KOSHIN PULVERIZADORES DE PRESSÃO PREVIA

**HS-503W**



**HS-703W**



**HS-401C**



	HS-503W	HS-703W	HS-401C
litros	5	7	5
	5m	5m	5m
Tipo pulverizador Type pulvérisateur Tipo de pulverizador	2 Etapas extensibles/ 2 boquillas 2 tronçons extensibles/ 2 buses 2 etapas extensíveis/ 2 bicos		1 Etapa extensible/ 1 boquilla 1 tronçon extensible/ 1 buse 1 etapa extensível/ 1 bicos
Longitud lanza Longueur lance Longitude braço	63-114cm	63-114cm	38cm
	5 bar	5 bar	4 bar
	21 min	31 min	20 min
-2	10 min	15 min	-
	56-73	79-99	46-59
(1)	195 x 195 x 630	195 x 195 x 630	190 x 190 x 405
(n)	420 x 420 x 665	420 x 420 x 665	600 x 413 x 437
Peso Poids Peso (Kg)	14	15	11,5
Unidades x embalaje Unités x emballage Unidades x embalagem	4	4	6
Código Code Código	<b>204100</b>	<b>204101</b>	<b>204102</b>

**MÉTODO DOBLE PISTÓN**  
SYSTÈME DOUBLE PISTON  
METODO DUPLO PISTÃO



1 boquilla • 1 buse • 1 bicos



2 boquillas • 2 buses • 2 bicos



MADE IN JAPAN

**KOSHIN**

GT-3



GT-5



GT-5H



	GT-3	GT-5	GT-5H
litros	3	5	5
	1,5 m	1,5 m	1,5 m
Tipo pulverizador Type pulverisateur Tipo de pulverizador	3 Etapas extensibles 1 boquilla 3 tronçons extensibles 1 buse 3 etapas extensíveis 1 bicos	3 Etapas extensibles 1 boquilla 3 tronçons extensibles 1 buse 3 etapas extensíveis 1 bicos	1 Etapa extensible + extensión+2 boquillas 1 tronçons extensibles + extensible + 2 buses 1 etapas extensíveis + extension + 2 bicos
Longitud lanza Longueur lance Longitude braço	43 - 100 cm	43 - 100 cm	59 - 96 cm
	DC 1,5V x 4	DC 1,5V x 4	DC 1,5V x 6
Volts	4,8	4,8	7,2
Alcalina Alcaline Alcalina	70 litros	70 litros	1 JET - 80 litros / 2 JET - 180 litros
Manganeso Manganèse Manganés	30 litros	30 litros	-
litros	240 abanico / 240 baisse pression 240 baixa pressão		1 JET 450 abanico / 450 baisse pression / 450 baixa pressão 570 chorro / 570 haute pression / 570 alta pressão
	400 chorro / 400 haute pression 400 alta pressão		2 JET 680 abanico / 680 baisse pression / 680 baixa pressão 740 chorro / 740 haute pression / 740 alta pressão
	13 min	21 min	-
	60°	60°	60°
	4 m	4 m	4 m
(n)	390 x 540 x 385	280 x 390 x 385	405 x 385 x 355
Peso Poids Peso (Kg)	8	4,5	5,1
Unidades x embalaje Unités x emballage Unidades x embalagem	4	2	2
Código Code Código	8469	8470	84701

- Gran y fácil abertura del depósito para su limpieza y llenado.
- Diseño inferior ligeramente inclinado para asegurar la absorción del líquido.
- Gran comodidad.
- Lista para su uso.
- Diseño ergonómico.

- Ouverture du reservoir ample et facile pour son nettoyage et remplissage.
- Cuve légèrement inclinée au fond pour assurer l'absorption totale du liquide.
- Grande commodité.
- Prêt pour, son utilization.
- Dessin ergonomique.

- Grande e fácil abertura do depósito para a sua limpeza e enchimento.
- Desenho inferior levemente inclinado para assegurar a absorção do líquido.
- Grande comodidade.
- Listo para o seu uso.
- Desenho ergonômico.

**CPHK-504**



**Compactas. Muy fáciles de usar ideales para huertas y jardinería.**

*Compacts. D'utilisation très facile, destinés aux particuliers pour les jardins et les cultures.*

*Compactas. Fáceis de usar ideais para hortas e jardins.*

- Ruedas neumáticas con cámara y llanta en PVC.
- Manetas abatibles para almacenaje.
- Depósito en polietileno alta densidad blanco con escala visible.
- Roues pneumatiques avec chambre à air et jantes en PVC.
- Poignées pliables pour stockage.
- Cuve polyéthylène blanc haute densité avec niveau visible.
- Rodas pneumáticas com câmara e aro em PVC.
- Gudão reclinável para estocagem.
- Deposito em polietileno alta densidade branco com escala visível.



Lanza acero con boquilla largo alcance, 80cm.

*Lance en acier avec buse à large portée, 80 cm.*

*Lança de aço com boquilha de longo alcance, 80 cm.*



**Motor GX-35 + BOMBA MORI**

Código Code Código **85225**

	<b>CPHK-504</b>
Motor <i>Moteur</i> Motor	GX-35
cm <sup>3</sup>	35
KW	1
	7000rpm 7000 tr/min
Arranque <i>Démarrage</i> Iniciar	Manual <i>Manuel</i> Manual
	4
Bomba <i>Pompe</i> Bomba	MORI Pistones <i>Pistons</i> Pistões
	50L
	35 bar
litros	8 l/min
(8 mm)	50m
	102 dB(A)
	720 x 470 x 440 + 870 x 590 x 590
	✓
Peso <i>Poids</i> Peso (Kg)	42
Código <i>Code</i> Código	<b>8756</b>



	CP4-502*	CP4-1001	CP4-1002	CP4-1002 (PA-430)
Motor Moteur Motor	RCX-80 / RCX-100			RCX-210
cm <sup>2</sup>	80/97			212
KW	1,7 / 1,4			4,4
	3600rpm 3600 tr/min			
Arranque Démarrage Iniciar	Manual Manuel Manual			
	2	1	2	2
Bomba Pompe Bomba	BERTOLINI De membrana A membrane De membrana			
	50L	100L	100L	100L
	20 bar	20 bar	20 bar	40 bar
litros	17 l/min	17 l/min	17 l/min	40 l/min
(8 mm)	10m	10m	10m	10m
	96 dB(A)	96 dB(A)	96 dB(A)	97 dB(A)
	850x530x710	1070x560x820	1100x700x880	
Peso Poids Peso (Kg)	27,5	30,5	42	52
	✓	✓	✓	✓
Código Code Código	8479	84191	84201	84292

\*El modelo CP4-502 sólo apto para jardinería. /  
Modèle CP4-502 pour jardins seulement. / O modelo CP4-502 só apto para jardim.

**Compactas. Muy fáciles de usar ideales para huertas y jardinería.**

Compacts. D'utilisation très facile, destinés aux particuliers pour les jardins et les cultures.

Compactas. Fáceis de usar ideais para hortas e jardins.

- Ruedas neumáticas con cámara y llanta en PVC.
- Manetas abatibles para almacenaje.
- Depósito en polietileno alta densidad blanco con escala visible.

- Roues pneumatiques avec chambre à air et jantes en PVC.
- Poignées pliables pour stockage.
- Cuve polyéthylène blanc haute densité avec niveau visible.

- Rodas pneumáticas com câmara e aro em PVC.
- Gudão reclinável para estocagem.
- Depósito em polietileno alta densidade branco com escala visível.



Manguera y pistola incluidas.  
Livrés avec tuyau et lance.  
Mangueira e pistola incluidas.

### ACCESORIOS OPCIONALES PARA CARRETTILLAS 100L ACCESSOIRES OPTIONNELS POUR PULVERISATEURS 100L ACESÓRIOS OPCIONAIS PARA CARROS 100L

#### Motor RCX-80 + BOMBA BERTOLINI

Código Code Código **85226**



#### Motor RCX-80 + BOMBA COMET MC25

Código Code Código **85221\*\*\***



#### \*\*\*Manómetro opcional

Código Code Código **32490**



#### Motor RCX-210 + BOMBA BERTOLINI PA-430

Código Code Código **85228**



## CP2-502



## CP2-1002N



**Compactas. Muy fáciles de usar ideales para huertas y jardinería.**  
 Compacts. D'utilisation très facile, destinés aux particuliers pour les jardins et les cultures.

Compactas. Fáceis de usar ideais para hortas e jardins.

- Ruedas neumáticas con cámara y llanta en PVC.
- Manetas abatibles para almacenaje.
- Depósito en polietileno alta densidad blanco con escala visible.
- Roues pneumatiques avec chambre à air et jantes en PVC.
- Poignées pliables pour stockage.
- Cuve polyéthylène blanc haute densité avec niveau visible.
- Rodas pneumáticas com câmara e aro em PVC.
- Gudão reclinável para estocagem.
- Deposito em polietileno alta densidade branco com escala visível.

Manguera y pistola incluidas.  
 Livrés avec tuyau et lance.  
 Mangueira e pistola incluidas.



	CP2-502	CP2-1002N
Motor <b>Moteur</b> Motor	0S-P768	0S-P768
cm <sup>2</sup>	25,4	25,4
KW	0,9	0,9
	7000 rpm 7000 tr/min	
Arranque <b>Démarrage</b> Iniciar	Manual <b>Manuel</b> Manual	
	2	2
Bomba <b>Pompe</b> Bomba	OUSEN Pistones <b>Pistons</b> Pistões	
	50L	100L
	25 bar	25 bar
litros	8 l/min	8 l/min
(8 mm)	10m	10m
	106 dB(A)	106 dB(A)
	850 x 530 x 710	1080 x 570 x 810
Peso <b>Poids</b> Peso (Kg)	27,5	36
	✓	✓
Código <b>Code</b> Código	<b>9133</b>	<b>9134</b>

### ACCESORIOS OPCIONALES PARA CARRETILLAS 100L ACCESSOIRES OPTIONNELS POUR PULVERISATEURS 100L ACESÓRIOS OPCIONAIS PARA CARROS 100L

#### Motor 2T 0S-P768 + BOMBA

Código **Code** Código **85227**



## CPH-502



## CPH-1001



## CPH-1002



Manguera y pistola incluidas.  
Livrés avec tuyau et lance.  
Mangueira e pistola incluídas.



**Compactas. Muy fáciles de usar ideales para huertas y jardinería.**

Compacts. D'utilisation très facile, destinés aux particuliers pour les jardins et les cultures.

Compactas. Fáceis de usar ideais para hortas e jardins.

- Ruedas neumáticas con cámara y llanta en PVC.
- Manetas abatibles para almacenaje.
- Depósito en polietileno alta densidad blanco con escala visible.
- Roues pneumatiques avec chambre à air et jantes en PVC.
- Poignées pliables pour stockage.
- Cuve polyéthylène blanc haute densité avec niveau visible.
- Rodas pneumáticas com câmara e aro em PVC.
- Gudão reclinável para estocagem.
- Deposito em polietileno alta densidade branco com escala visível.

	CPH-502	CPH-1002H	CPH-1001	CPH-1002
Motor Moteur Motor	GX-35	GX-35	GXR-120	GXR-120
cm <sup>3</sup>	35	35	121	121
KW	1	1	2,3	2,3
	7000 rpm	7000 tr/min	3600 rpm	3600 tr/min
Arranque Démarrage Iniciar	Manual Manuel Manual			
	2	2	1	2
Bomba Pompe Bomba	MORI	MORI	COMET	COMET
	Pistones Pistons Pistões / De membrana A membrane De membrana			
	50L	100L	100L	100L
	35 bar	35 bar	25 bar	25 bar
litros	8 l/min	8 l/min	23 l/min	23 l/min
(8 mm)	10m	10m	10m	10m
	102 dB(A)	102 dB(A)	96 dB(A)	96 dB(A)
	850 x 530 x 710	1100 x 700 x 880	1070 x 560 x 820	1100 x 700 x 880
Peso Poids Peso (Kg)	27,5	42	28,5	40
	✓	✓	✓	✓
Código Code Código	<b>8785</b>	<b>87851</b>	<b>84281</b>	<b>8428</b>

### ACCESORIOS OPCIONALES PARA CARRETTILLAS 100L ACCESSOIRES OPTIONNELS POUR PULVERISATEURS 100L ACESÓRIOS OPCIONAIS PARA CARROS 100L

#### Motor GX-100 + BOMBA COMET MC25

Código Code Código **8522\*\*\***

#### \*\*\*Manómetro opcional

Código Code Código **32490**

#### Motor GX-35 + BOMBA MORI

Código Code Código **85225**



## CPE-1001



## CPE-1002



**Compactas. Muy fáciles de usar ideales para huertas y jardinería.**

Compacts. D'utilisation très facile, destinés aux particuliers pour les jardins et les cultures.

Compactas. Fáceis de usar ideais para hortas e jardins.

- Ruedas neumáticas con cámara y llanta en PVC.
- Manetas abatibles para almacenaje.
- Depósito en polietileno alta densidad blanco con escala visible.
- Roues pneumatiques avec chambre à air et jantes en PVC.
- Poignées pliables pour stockage.
- Cuve polyéthylène blanc haute densité avec niveau visible.
- Rodas pneumáticas com câmara e aro em PVC.
- Gudão reclinável para estocagem.
- Depósito em polietileno alta densidade branco com escala visível.

Manguera y pistola incluidas.  
Livrés avec tuyau et lance.

Manguera e pistola incluidas.



	CPE-1001	CPE-1002
Motor Moteur Motor	ELECTRICO ÉLECTRIQUE ELÉTRICO	
KW	0,75	0,75
	1400rpm 1400 tr/min	
Arranque Démarrage Iniciar	Manual Manuel Manual	
	1	2
Bomba Pompe Bomba	BERTOLINI	
	De membrana A membrane De membrana	
	100L	100L
	20 bar	20 bar
litros	17 l/min	17 l/min
(8 mm)	10m	10m
	85 dB(A)	85 dB(A)
	1070 x 560 x 820	1100 x 700 x 880
Peso Poids Peso (Kg)	33	44
	✓	✓
Código Code Código	<b>85191</b>	<b>85192</b>

### ACCESORIOS OPCIONALES PARA CARRETILOS 100L ACCESSOIRES OPTIONNELS POUR PULVERISATEURS 100L ACESÓRIOS OPCIONAIS PARA CARROS 100L

#### Motor ELECTRICO + BOMBA BERTOLINI

Código Code Código **85223**



#### Motor ELÉCTRICO + Bomba MC25

Código Code Código **85229\*\*\***

\*\*\*Manómetro opcional

Código Code Código **32490**







Código Code Código	Descripción Description Descrição		
32466	50L-2R / 100L-1R Soporte enrollador rojo Support enrouleur rouge Suporte de enrolamento vermelho	✓	✓
32467	100L-2R Soporte enrollador rojo Support enrouleur rouge Suporte de enrolamento vermelho	—	✓
32468	Enrollador metálico zincado 50 m Enrouleur métallique zingué 50 m Enrolador metalico galvanizado 50m	✓	✓
32469	Barra herbicida 2m - 5 jets Para modelo 100L Barre herbicide 2m - 5 jets Pour modèle 100L Barra herbicida 2m - 5 jets Para modelo 100L	—	✓
32470	Rollo manguera 50m/8mm-50 Atm, c/rácores Enrouleur tuyau 50m/8mm-50 bars, avec raccords Rolo mangueira 50m/8mm-5Atm. c/uniões	✓	✓
32552	Pistolete sin fin 0,6 m Pistolet sans fin 0,6 m Pistoletes sem fim 0,6 m	✓	✓
32551	Pistolete sin fin 1 m Pistolet sans fin 1 m Pistoletes sem fim 1 m	✓	✓
32484	Pistola 25 bar Lance 25 bars Pistola M. 94	✓	✓
32553	Pistola M. 94 Lance M. 94 Pistola M. 94	✓	✓
32554	Pistolete turbo sin fin - racor giratorio Pistolet turbo M. 2011 Pistola turbo M. 2011	✓	✓
32585	Lanza acero c/boquilla largo alcance 0,8m Lance en acier avec buse a large portée 0,8m Lança de aço boquilla de longo alcance 0,8m	✓	✓
72024N	neumática / pneumatique / pneumática 3.00-4 medidas / mesures / medição 260X85mm carga / charge / carga 136kg eje / axe / eixos 20mm • lonas / bâches / lonas 4PR	✓	✓
33745N	neumática / pneumatique / pneumática 3.50-8 medidas / mesures / medição 370X80mm carga / charge / carga 160kg eje / axe / eixos 20mm • lonas / bâches / lonas 4PR	✓	✓
72024M	Maciza / Pleine / Sólida 3.00-4 medidas / mesures / medição 260X85mm carga / charge / carga 136kg eje axe eixos 20mm • lonas / bâches / lonas PU	✓	✓
33745M	Maciza Pleine Sólida 3.50-8 medidas mesures medição 370X80mm carga charge carga 160 kg eje axe eixos 20mm • lonas bâches lonas PU	✓	✓
33766	Para modelo pour Modèle Para modelo 3.50-8 Medidas mesures medição L=166 eje axe eixos 20mm FE	✓	✓

ACCESORIOS OPCIONALES PARA CARRETILAS 50 /100L • ACCESÓIRES OPTIONNELS POUR PULVERISATEURS 50 /100L • ACCESÓIRES OPCIONAIS PARA CARROS 50 /100L





## BV-3405

NEW



## CEB-800



	BV-3405	CEB-800
Motor Moteur Motor	Gasolina 2T Esence 2T Gasolina 2T	Gasolina 2T Esence 2T Gasolina 2T
 cm <sup>2</sup>	25,4	79,4
 KW	0,75	3,0
Volumen aire Volume d'air Volume do ar	10,6m <sup>3</sup> /min	27m <sup>3</sup> /min
Velocidad aire Vitesse d'air Velocidade do ar	225,7Km/h	331Km/h
 cm	40 L	-
LWA dB (A)	108	99
Función Utilisation Função	Aspirador-Soplador- Triturador Aspirateur-Souffleur-Broyeur Aspirador-Soprador-Triturador	Soplador Souffleur Soprador
 mm	555 x 280 x 385	515 x 405 x 530
Peso Poids Peso (Kg)	7,5	11
Código Code Código	9999	8578

### CARACTERÍSTICAS TÉCNICAS BV 3405

CARACTÉRISTIQUES TECHNIQUES BV 3405

CARACTERÍSTICAS TÉCNICAS BV 3405

- Aspirador con turbina trituradora.
- Reducción del volumen de materia aspirada de 10 a 1.
- Conversión rápida función aspirador en función soplante.
- Empuñadura ergonómica.
- Saco vaciable fácilmente y rápidamente.
- Aspirateur avec turbine de broyage.
- Réduction du volume par broyage 10:1.
- Conversion instantanée d'aspirateur en souffleur.
- Poignée ergonomique.
- Vidange du sac facile et rapide.
- Aspirador com turbina trituradora.
- Redução do volume de matéria aspirada de 10 a 1.
- Conversão rápida da função aspiradora em função de assopra.
- Empunhadura/Gudão ergonômico.
- Saco que se esvazia fácil e rapidamente.

## TAURUS-L46T





## TAURUS-L51T



## WYS16-1P65FE



	TAURUS-L46T	TAURUS-L51T	WYS16
	Acero/ Acier/ Aço SP: 1,6mm	Acero/ Acier/ Aço SP: 1,8mm	Acero/ Acier/ Aço SP: 1,6mm
Motor Moteur Motor	LONCIN 1P65FE	LONCIN 1P70FA	LONCIN 1P65FE
	2,4 Kw / 3600 rpm	3,6 Kw / 3600 rpm	2,2 Kw / 3600 rpm
	139	196	123
Arranque Démarrage Iniciar	Manual Manuel Manual		
	Tela americana Tissu Tela americana		
	60	65	45
	178x51mm	178x51mm	178x51mm
	254x56mm	254x56mm	178x51mm
	✓	✓	-
	Regulable Réglage variable Ajustável		
	46	51	41
	25/75(6)	25/75(6)	30/90(6)
	✓	✓	✓
<b>Mulching</b>	✓	✓	-
Descarga lateral Vidange latérale Descarga lateral	✓	✓	-
	<= 98dB(A)	<= 98dB(A)	<= 98dB(A)
	820x570x460	880x570x460	720x510x430
	1.200	2.000	800
Peso Poids Peso (Kg)	33	35	23
Código Code Código	<b>9201</b>	<b>9205</b>	<b>9216</b>

# JARDÍN

JARDIN  
JARDIN

**TAURUS-53 TWA ALU**



**TAURUS-L51 Ti**



**TAURUS 46 T**



**(1) SOLO HASTA FIN DE STOCKS**  
STOCKS RÉDUITS  
SÓ ATÉ O FIM DAS EXISTÊNCIAS

	TAURUS-53 TWA ALU	TAURUS L51Ti INSTART	TAURUS-46T <sup>(1)</sup>
	Aluminio Aluminium Aluminio	Acero Acier Aço SP: 1,8mm	Acero Acier Aço SP: 1,6mm
Motor Moteur Motor	BRIGGS&STRATTON BS675 EXI	LONCIN 1P70PE	BRIGGS&STRATTON BS500E
	2600 rpm 2600 tr/mn 2600 rpm	2600 rpm 2600 tr/mn 2600 rpm	2600 rpm 2600 tr/mn 2600 rpm
	163	196	140
Arranque Démarrage Iniciar	Manual Manuel Manual	Manual Manuel Manual	Manual Manuel Manual
	-	✓	-
	✓	-	-
	Tela americana Tissu Tela americana		
	70	65	60
	203 x 56mm	178 x 51mm	178 x 51mm
	280 x 56mm	245 x 56mm	203 x 56mm
	✓	✓	✓
	Regulable Réglage variable Ajustável		
	53	51	46
	25/80(7)	27/75(6)	50/75(5)
	✓	✓	✓
Mulching	✓	✓	-
Descarga lateral Vidange latérale Descarga lateral	-	✓	-
	<= 98dB(A)	<= 98dB(A)	<= 98dB(A)
	920 x 610 x 520	910 x 570 x 520	850 x 560 x 440
	2500	2000	1200
Peso Poids Peso (Kg)	49	35	34
Código Code Código	<b>9080</b>	<b>92051</b>	<b>9077</b>

## BB C 150-84 / BB C170-98

**NEW**



Transmisión hidrostática a pedales  
Transmission hydrostatique à pédale  
Transmissão hidrostática do pedal



Enganche electromagnético de cuchillas  
Engagement électromagnétique de la lame  
Engate eletromagnético da lâmina



Parachoques  
Pare-chocs  
Parachoques



Kit mulching  
Kit mulching  
Kit mulching



Cargador/mantenedor de batería incluido  
Chargeur/mainteneur de batterie inclus  
Carregador/mantenedor de bateria incluido

	BB C 150-84	BB C170-98
Motor <b>Moteur</b> Motor	Loncin LC1P90F-1	Loncin LC1P92-F1
	8,8 Kw/ 3600 rpm	9,2 KW/ 3600 rpm
	432 cc	452 cc
Arranque <b>Démarrage</b> Iniciar	Eléctrico <b>Électrique</b> Elétrico	
	Tela americana <b>Tissu</b> Tela americana	
	240 L	240 L
	13x5,00-6	13x5,00-6
	18x8,50-8	18x8,50-8
	Hydrostatic transmission	
	84 cm (33")	98 cm (38")
	25/80 (7)	25/80 (7)
<b>Mulching</b>	✓	✓
Descarga lateral <b>Vidange latérale</b> Descarga lateral	✓	✓
	100 db(A)	100 db(A)
	4500	4500
	2340x902x1098	2340x1020x1098
Peso <b>Poids</b> Peso (Kg)	224	240
Código <b>Code</b> Código	<b>8993</b>	<b>8994</b>

## TM-360 MINI



## C-1300



	TM-360 MINI	C-1300
	0+1	0+1
Transmisión Transmission Transmissao	Correa y engranaje Courroie et engrenage Corrente e por pinhão	Correa y engranaje Courroie et engrenage Corrente e por pinhão
Motor Moteur Motor	CAMPEON ECO-150	ELECTRICO
kW	2,5	1300W-230V-50HZ
cm <sup>2</sup>	150	-
	Cartucho papel Cartouche papier Cartucho de papel	-
mm	360/600	360
mm	250	250
	4(300mm)	4(240mm)
	2(200mm)	-
	✓	✓
	96dB(A)	80,8dB(A)
mm	680x390x660	750x420x600
Peso Poids Peso (Kg)	32	23
Código Code Código	<b>95043</b>	<b>9329</b>

### ACCESORIOS OPCIONAL ENSURCADOR FIJO ACCESSOIRES OPTIONNEL BUTTOIR ACESÓRIOS OPCIONAIS SULCADOR

TM-360

Código Code Código













**5750**



TM-450 G

TM-450 GR



	TM-450G	TM-450GR
	0+1	0+1 -1
 Transmisión Transmission Transmissao	Cadena y correa <b>Chaîne et courroie</b> Aparafusada <b>Correia e corrente</b>	
Motor <b>Moteur</b> Motor	G200F	G200FR
 kW	4,1	4,1
 cm <sup>3</sup>	196	196
	Baño de aceite <b>Bain d'huile</b> <b>Banho de óleo</b>	
 mm	600/800	600/800
 mm	150/250	150/250
	6(300mm)	6(300mm)
	2(200mm)	2(200mm)
	Regulable <b>Réglage variable</b> <b>Regulavel</b> Desplazable lateralmente <b>Désplaçable latéralment</b> <b>Lateralmente deslocável</b>	
	✓	✓
	96dB(A)	96dB(A)
 mm	790 x 450 x 780	790 x 450 x 780
Peso <b>Poids</b> <b>Peso</b> (Kg)	58	60
Código <b>Code</b> <b>Código</b>	<b>9479</b>	<b>9485</b>

**KIT ARRANCA PATATAS 7 VARILLAS**  
**KIT ARRACHEUSES DE POMMES DE TERRE**  
**KIT ARRANCADOR DE BATATAS 7 VARETAS**

Código **Code** **Código**

**5719**



**KIT ARADO LATERAL**  
**KIT CHARRUE LATÉRALE**  
**KIT CHARRUA LATERAL**

Código **Code** **Código**

**5721**



**TM-500 G2R**



	<b>TM-500 G2R</b>
	-1 0 +1 +2
Transmisión Transmission Transmissao	Cadena y correa <b>Chaîne et courroie</b> Aparafusada/ <b>Correia e corrente</b>
Motor <b>Moteur</b> Motor	ECO-200C
kW	4,1
cm <sup>3</sup>	196
	Baño de aceite <b>Bain d'huile</b> <b>Banho de óleo</b>
mm	600/800
mm	150/250
	6(300mm)
	2(245mm)
	Regulable <b>Réglage variable</b> <b>Regulavel</b>
	✓
	✓
	97db(A)
mm	820 x450 x780
Peso <b>Poids</b> <b>Peso</b> (Kg)	88
Código <b>Code</b> <b>Código</b>	<b>8401R2</b>

**ACCESORIOS OPCIONAL / ACCESSOIRES OPTIONNEL / ACESÓRIOS OPCIONAI**

		400 x 8		288 x 100
	KIT APORCADOR TM-500 <b>KIT OUVRE-SILLON TM-500</b> KIT ABRE-REGOS TM-500	RUEDAS NEUMÁTICAS TM-500 <b>ROUES PNEUMATIQUES</b> RODAS PNEUMÁTICAS	KIT LABOUR(1) TM-500	RUEDAS METÁLICAS TM-500 <b>ROUES METALLIQUES</b> RODAS METÁLICAS
Código <b>Code</b> <b>Código</b>	<b>5730</b>	<b>5711</b>	<b>9910</b>	<b>5743</b>
	Incluidas <b>Comprises</b> <b>Incluidas</b>	Incluidas <b>Comprises</b> <b>Incluidas</b>	—	—





**TM-500 G2R PRO**

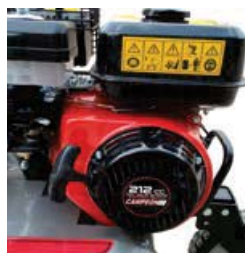

	TM-500 G2R PRO
	-1 0 +1 +2
Transmisión Transmission Transmissao	Cadena y correa <b>Chaîne et courroie</b> Aparafusada/ <b>Correia e corrente</b>
Motor <b>Moteur</b> Motor	RCX-210C
kW	4,4
cm <sup>3</sup>	212
	Baño de aceite <b>Bain d'huile</b> <b>Banho de óleo</b>
mm	600/800
mm	150/250
	6(300mm)
	2(245mm)
	Regulable <b>Réglage variable</b> <b>Regulavel</b>
	✓
	✓
	96db(A)
mm	900x380x775
Peso <b>Poids</b> <b>Peso</b> (Kg)	82
Código <b>Code</b> <b>Código</b>	<b>8401R2PRO</b>

**ACCESORIOS OPCIONAL / ACCESSOIRES OPTIONNEL / ACESÓRIOS OPCIONAL**

		400 x 8	288 x 100
	APORCADOR TM-500 PRO <b>OUVRE-SILLON TM-500 PRO</b> ABRE-REGOS TM-500 PRO	RUEDAS NEUMÁTICAS TM-500 <b>ROUES PNEUMATIQUES</b> RODAS PNEUMÁTICAS	RUEDAS METÁLICAS TM-500 <b>ROUES METALLIQUES</b> RODAS METÁLICAS
Código <b>Code</b> <b>Código</b>	<b>9820</b>	<b>5711</b>	<b>5743</b>
	Incluidas <b>Comprises</b> <b>Incluidas</b>	Incluidas <b>Comprises</b> <b>Incluidas</b>	—

TM-500 H2R



	TM-500 H2R GP-160	TM-500 H2R GX-200
	-1 0 +1 +2	-1 0 +1 +2
Transmisión Transmission Transmissao	Cadena y correa <i>Chaîne et courroie</i> Aparafusada/ Correira e corrente	
Motor <i>Moteur</i> Motor	HONDA GP-160	HONDA GX-200
kW	3,6	4,3
cm <sup>3</sup>	163	196
	Cartucho papel <sup>(2)</sup> <i>Cartouche papier</i> Cartucho de papel	Baño de aceite <i>Bain d'huile</i> Banho de óleo
mm	600/800	600/800
mm	150/250	150/250
	6(300mm)	6(300mm)
	2(245mm)	2(245mm)
	Regulable <i>Réglage variable</i> Regulavel	
	✓	✓
	✓	✓
	96db(A)	97db(A)
mm	820x450x780	820x450x780
Peso <i>Poids</i> Peso (Kg)	81	82
Código <i>Code</i> Código	<b>8608</b>	<b>8725R2</b>

(2) Opcional filtro de aire en baño de aceite, Cod 51-0100

(1) Motoazada no incluida  
*Motobineuse non inclus*  
Motoenzada não incluida

### ACCESORIOS OPCIONAL / ACCESSOIRES OPTIONNEL / ACESÓRIOS OPCIONAL

		400 x 8		288 x 100
	KIT APORCADOR TM-500 <i>KIT OUVRE-SILLON TM-500</i> KIT ABRE-REGOS TM-500	RUEDAS NEUMÁTICAS TM-500 <i>ROUES PNEUMATIQUES</i> RODAS PNEUMÁTICAS	KIT LABOUR(1) TM-500	RUEDAS METÁLICAS TM-500 <i>ROUES METALLIQUES</i> RODAS METÁLICAS
Código <i>Code</i> Código	<b>5730</b>	<b>5711</b>	<b>9910</b>	<b>5743</b>
	Incluidas <i>Comprises</i> Incluidas	Incluidas <i>Comprises</i> Incluidas	—	—

**TM-900 G**



**TM-900 D**

**DIESEL**



**TM-900 D E-START**



	TM-900 G	TM-900 D	TM-900 D E-START
	-1 0 +1 +2	-1 0 +1 +2	-1 0 +1 +2
Transmisión Transmission Transmissao	Engranajes Engrenages Por pinhão		
Motor Moteur Motor	G200FE	DIESEL D350F	DIESEL D350F
kW	4,1	4,9	4,9
cm <sup>3</sup>	196	349	349
	Baño de aceite Bain d'huile Banho de óleo		
mm	600/900/1050	600/900/1050	600/900/1050
mm	150/300	150/300	150/300
	6+2	6+2	6+2
	✓	✓	✓
	Regulable Réglage variable Regulavel Desplazable lateralmente Déplaçable latéralment Lateralmente deslocável		
Arranque Démarrage Iniciar	Manual Manuel Manual		Eléctrico Électrique Elétrico
	-	-	Incluida Inklus Include
	400x8	500x12	500x12
	97dB(A)	106dB(A)	106dB(A)
mm	770 x 510 x 740	770 x 510 x 740	770 x 510 x 740
Peso Poids Peso (Kg)	90	109	111
Código Code Código	<b>9900</b>	<b>9915</b>	<b>9915E</b>

**ACCESORIOS OPCIONAL / ACCESSOIRES OPTIONNEL / ACESÓRIOS OPCIONAL**

	APORCADOR EXTENSIBLE OUVRE-SILLON ABRE-REGOS	RUEDAS NEUMÁTICAS ROUES PNEUMATIQUES RODAS PNEUMÁTICAS		KIT BOMBA 2" KIT POMPE 2" KIT BOMBA 2"	RUEDAS METÁLICAS ROUES METALLIQUES RODAS METÁLICAS
Código Code Código	<b>9820</b>	<b>5716</b>	<b>5718</b>	<b>5717</b>	<b>5742</b>
	Incluidas Comprises Includidas	Incluidas Comprises Includidas <b>TM-900G</b>		-	-

## TM-1100G(6S)



	TM-1100G(6S)
	-1 0 +1 +2
 Transmisión Transmission Transmissao	Engranajes Engrenages Por pinhão
Motor Moteur Motor	ECO210
 kW	4,4
 cm <sup>3</sup>	212
	Baño de aceite Bain d'huile Banho de óleo
 mm	800/1000
 mm	150/300
	6
	✓
	Regulable Réglage variable Regulavel
Arranque Démarrage Iniciar	Manual Manuel Manual
	400x8
	97dB(A)
 mm	940 X 580 X 750
Peso Poids Peso (Kg)	104
Código Code Código	<b>9200</b>

### ACCESORIOS OPCIONAL / ACCESSOIRES OPTIONNEL / ACESÓRIOS OPCIONAL

		400 x 8 	380 x 126 
	KIT APORCADOR EXTENSIBLE(1) TM-1100 KIT OUVRE-SILLON (1) TM-1100 KIT ABRE-REGOS (1) TM-1100	RUEDAS NEUMÁTICAS TM-1100 ROUES PNEUMATIQUES RODAS PNEUMÁTICAS	RUEDAS METÁLICAS TM-1100 ROUES METALLIQUES RODAS METÁLICAS
Código Code Código	<b>5730</b>	<b>5711</b>	<b>5744</b>
	Incluidas Comprises Incluidas	Incluidas Comprises Incluidas	—

TM-1100G (65) ACCESORIOS OPCIONAL / ACCESSOIRES OPTIONNEL / ACESÓRIOS OPCIONAI

<p><b>NEW</b></p>		
	<p>KIT FRESA TRASERA ANCHO DE TRABAJO 600 mm KIT FRAISE ARRIERE LARGUER DE TRAVAIL 600 mm KIT FREISA TRASEIRA LARGURA DE TRABALHO 600 mm</p>	<p>KIT APORCADOR TRASERO SURCOS ENTRE HILERAS 300 mm KIT BUTTEUR ARRIERE SILLONS ENTRE LES RANGÉES 300 mm KIT ABRE-REGOS TRASEIRO RANHURAS ENTRE FILEIRAS 300 mm</p>
<p>Código Code Código</p>	<p>5765</p>	<p>5770</p>
<p><b>NEW</b></p>		
	<p>KIT CORTACÉPES ANCHO DE TRABAJO 800 mm KIT TONDEUSES LARGUER DE TRAVAIL 880 mm KIT CORTARELVAS LARGURA DE TRABALHO 880 mm</p>	<p>KIT SEGADORA ANCHO DE CORTE 950 mm KIT TONDEUSES LARGUER DE COUPE 950 mm KIT SEGADORA LARGURA DE CORTE 950 mm</p>
<p>Código Code Código</p>	<p>5772</p>	<p>5774</p>

<sup>(1)</sup> Motoazada no incluida / Motobineuse non inclus / Motoenzada não incluída





## EURO 102 GX-200



## EURO 102 GX-200

	-1 0 +1 +2 +3
 Transmisión Transmission Transmissao	Engranajes Engrenages Por pinhão
Motor Moteur Motor	HONDA GX-200
 kW	4,3
 cm <sup>2</sup>	196
	Baño de aceite Bain d'huile Banho de óleo
 mm	650/950
 mm	150/300
	6 (340mm)
	2 (245mm)
	Regulable Réglage variable Regulavel
Arranque Démarrage Iniciar	Manual Manuel Manual
	-
	97dB(A)
 mm	950x505x900mm + 480x360x350mm
Peso Poids Peso (Kg)	96
Código Code Código	<b>8990</b>

### ACCESORIOS OPCIONAL / ACCESSOIRES OPTIONNEL / ACESÓRIOS OPCIONAL

			
KIT RUEDAS 500X10 Ejes + ruedas neumáticas KIT ROUES 500X10 Essieux + roues pneumatiques KIT RODAS 500X10 Eixos + rodas pneumáticas	KIT RUEDAS TRANSPORTE 42x4 cm con montaje sobre discos KIT ROUES TRANSPORT 42x4 cm montage sur disques KIT RODAS TRANSPORTE 42x4 cm montagem em discos	KIT EXTENSION FRESAS Ancho de trabajo 1250 mm KIT EXTENSION FRAISE Largueur de travail 1250 mm KIT EXTENSION FRESAS Largo de trabalho 1250 mm	KIT APORCADOR EXTENSIBLE KIT OUVRE-SILLON KIT ABRE-REGOS
Código Code Código	<b>33605 + 9801</b>	<b>33615</b>	<b>33620</b>

**TM-720 GX**



**TM-720 DX E-START**



	TM-720 GX	TM-720 DX E-START
Transmisión Transmission Transmissao	-2 -1 0 +1 +2 +3	
Motor <b>Moteur</b> Motor	ECO 270Q	DIESEL GE-178D
kW	6,5	4,5
	-	Incluida Inclus Include
cm <sup>2</sup>	270	296
	Baño de aceite <b>Bain d'huile</b> Banho de óleo	
mm	406/508/660	406/508/660
mm	150/300	150/300
	Regulable <b>Réglage variable</b> Regulavel	
Arranque <b>Démarrage</b> Iniciar	Manual <b>Manuel</b> Manual	Eléctrico <b>Électrique</b> Eléctrico
	400x10	400x10
	98dB(A)	106dB(A)
mm	850 x 720 x 600 + 550 x 720 x 450	1120 x 620 x 600 + 550 x 720 x 450
Peso <b>Poids</b> Peso (Kg)	135	161
Código <b>Code</b> Código	<b>203932</b>	<b>203935E</b>

TM-720X (400X8)	1ª	2ª	3ª	1ª R	2ª R	PTO
Km/h	1,12	2,6	11,91	1,55	3,58	990 rpm

**ACCESORIOS OPCIONAL / ACCESSOIRES OPTIONNEL / ACESÓRIOS OPCIONAL**

	ASURCADOR + CONTRAPESOS 32KG (16X2) OUVRE-SILLON + CONTRAPOIDS 32KG (16X2) ABRE-REGOS + PESOS 32KG (16X2)	JUEGO FRESAS JEUX DE FRAISES CONJUNTO DE FRESAS		KIT LABOUR(1) TM-500
Código <b>Code</b> Código	<b>5760</b>	<b>5720</b>		<b>9911</b>

(1) Motocultor y ruedas 500x10 no incluidos / **Motoculteur et roues 500x10 non inclus /**  
**Motocultivador e rodas não incluídos**

TM-730 G

NEW



TM-730GX E-START



NEW



	TM-730 G	TM-730GX E-START	TM-730 DX E-START
Transmisión Transmission Transmissao	-2 -1 0 +1 +2 +3	-2 -1 0 +1 +2 +3	-2 -1 0 +1 +2 +3
Motor Moteur Motor	G200F	G420FD-1	KM 186FE
	✓	✓	✓
kW	4,1 / 3600 rpm	9 / 3600 rpm	6,6 / 3600 rpm
	-	Incluída Inclus Include	Incluída Inclus Include
cm <sup>3</sup>	196	420	406
	Baño de aceite Bain d'huile Banho de óleo		
mm	500/650	500/650	500/650
mm	150/300	150/300	150/300
	Regulable Réglage variable Regulavel		
Arranque Démarriage Iniciar	Manual Manuel Manual	Eléctrico Électrique Elétrico	
	500X10	500X10	500X10
	97db(A)	97db(A)	106db(A)
mm	104x61,5x77,5 71x51x37	104x61,5x77x5 71x51x37	104x61,5x77x5 71x51x37
Peso Poids Peso (Kg)	140	155	185
Código Code Código	<b>8886</b>	<b>8887</b>	<b>8888E</b>









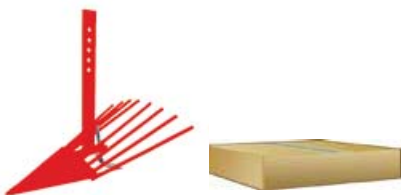

ACCESORIOS OPCIONAL / ACCESSOIRES OPTIONNEL / ACESSÓRIOS OPCIONAL

	600 x 12		
ENSURCADOR REGULABLE OUVRE-SILLON RÉGLAGE VARIABLE ABRE-REGOS REGULAVEL	RUEDAS NEUMÁTICAS ROUES PNEUMATIQUES RODAS PNEUMÁTICAS	KIT SEGADORA 120 cm KIT FAUCHEUSES 120 cm KIT GADANHEIRA 120 cm	JUEGO FRESAS JEUX DE FRAISES CONJUNTO DE FRESAS
Código Code Código	<b>5777</b>	<b>5778</b>	<b>5776</b>
			<b>5775</b>



Código Code Código	Descripción Description Descrição
9800	2 Ruedas neumáticas 400x8
	2 Roues pneumatiques 400x8
	2 Rodas pneumáticas 400x8
9801	2 Ruedas neumáticas 500x10
	2 Roues pneumatiques 500x10
9802	2 Ruedas neumáticas 500x12
	2 Roues pneumatiques 500x12
9807	2 Ruedas metálicas 340x80 (precisan adaptador)
	2 Roues metalliques 340x80 (adaptateur nécessaire)
	2 Rodas metálicas 340x80 (precisam adaptador)
9809	2 Ruedas metálicas 340x100 (precisan adaptador)
	2 Roues metalliques 340x100 (adaptateur nécessaire)
9811	2 Adaptadores para ruedas - REDONDO 25 mm - L=60mm
	2 Moyeux pour roues - ROND 25 mm - L=60mm
9882	2 Adaptadores para ruedas - REDONDO 28 mm - L=250mm
	2 Moyeux pour roues - ROND 28 mm - L=250mm
9814	2 Ruedas laterales transporte 400x40 (3 taladros)
9815D	Arrancador de patatas 8 varillas desmontable (precisan adaptador)
	Arracheuses de pommes de terre avomible (adaptateur nécessaire)
9816	Arrancador de patatas 10 varillas (precisan adaptador)
	Arracheuses de pommes de terre (adaptateur nécessaire)
9817	Adaptador CORTO
	Adaptateur COURT
9818	Adaptador LARGO
	Adaptateur LONG



Código Code Código	Descripción Description Descrição
	Arado semirotativo 1/2 vuelta giratorio
	<b>9819</b> Charrue giratorio 1/2 tour
	Charrua semirotativo Reversível
	Asurcador agrícola (precisa adaptador)
	<b>9820</b> Ouvre-sillon (adaptateur nécessaire)
	Abre-regos (precisam adaptador)
	Asurcador "SUPER" (precisa adaptador)
	<b>9821</b> Ouvre-sillon "SUPER" (adaptateur nécessaire)
	Abre-regos "SUPER" (precisam adaptador)
	Arado reversible fijo "370" (precisa enganche de casquillo)
	<b>9822</b> Charrue reversible à lames fixes "370" (enclenchement nécessaire)
	Charrua reversível fixo de varetas "370" (Necessita engate de casquilho)
	Arado reversible desplazable "300" (precisa enganche de casquillo)
	<b>9823</b> Charrue reversible à lames déportables "300" (enclenchement nécessaire)
	Charrua reversível descentrável de varetas "300" (Necessita engate de casquilho)
	Arado reversible desplazable "370" (precisa enganche de casquillo)
	<b>9825</b> Charrue reversible à lames déportables "370" (enclenchement nécessaire)
	Charrua reversível descentrável de varetas "370" (Necessita engate de casquilho)
	Enganche de casquillo 60/75
	<b>9828</b> Enclenchement 60/75
	Engate de casquilho 60/75
	Enganche de casquillo 63/80
	<b>9834</b> Enclenchement 63/80
	Engate de casquilho 63/80
	Arado vertedera 1/2 vuelta (precisa soporte)
	<b>9835</b> Charrue réversible 180°
	Charrua reversível de 180° (Necessita suporte)
	Soporte arado vertedera
	<b>9848</b> Support de charrue réversible
	Suporte charrua reversível

Código Code Código	Descripción Description Descrição
	2 Ejes desbloqueo - HEXAGONAL 23 mm
	9849 <b>Pair de moyeux axe fixe - HEXAGONAL 23 mm</b> 2 Eixos de desbloqueio - HEXAGONAL 23 mm
	2 Ejes desbloqueo - HEXAGONAL 27 mm
	9850 <b>Pair de moyeux axe fixe - HEXAGONAL 27 mm</b> 2 Eixos de desbloqueio - HEXAGONAL 27 mm
	2 Ejes desbloqueo extensibles - HEXAGONAL 23 mm
	9862 <b>Pair de moyeux rotatifs réglables en largeur - HEXAGONAL 23 mm</b> 2 Eixos de desbloqueio extensíveis - HEXAGONAL 23 mm
	2 Ejes desbloqueo extensibles - HEXAGONAL 27 mm
	9865 <b>Pair de moyeux rotatifs réglables en largeur - HEXAGONAL 27 mm</b> 2 Eixos de desbloqueio extensíveis - HEXAGONAL 27 mm
	2 Extensores de rueda con platina - HEXAGONAL 23 mm
	9871 <b>2 Moyeux roues - HEXAGONAL 23 mm</b> 2 Extensor de roda com platina - HEXAGONAL 23 mm
	2 Extensores de rueda con platina - HEXAGONAL 27 mm
	9874 <b>2 Moyeux roues - HEXAGONAL 27 mm</b> 2 Extensor de roda com platina - HEXAGONAL 27 mm
	2 Extensores de rueda con platina - HEXAGONAL 32 mm
	9907 <b>2 Moyeux roues - HEXAGONAL 32 mm</b> 2 Extensor de roda com platina - HEXAGONAL 32 mm
	2 Contrapesos 40 Kg para rueda neumática 400x8
	9878 <b>2 Contrepoids 40 Kg pour roues pneumatiques 400x8</b> 2 Pesos 40 Kg para rodas pneumáticas 400x8
	2 Contrapesos 40 Kg para rueda neumática 500x10
	9879 <b>2 Contrepoids 40 Kg pour roues pneumatiques 500x10</b> 2 Pesos 40 Kg para rodas pneumáticas 500x10
	2 Contrapesos 40 Kg para rueda neumática 500x12
	9880 <b>2 Contrepoids 40 Kg pour roues pneumatiques 500x12</b> 2 Pesos 40 Kg para rodas pneumáticas 500x12
	1 Contrapeso FRONTAL 25 Kg (precisa barra contrapeso)
	9881 <b>2 Contrepoids 40 Kg pour roues pneumatiques 500x12</b> 1 Peso FRENTE 25 Kg (precisam adaptador)
	Barra contrapeso (Serie TM-500)
	33482 <b>Bar contrepoid (Serie TM-500)</b> Bar peso (Serie TM-500)
	Juego de fresas completo + discos (6 fresas - 24 cuchillas) - HEXAGONAL 23 mm
	9901 <b>Jeu de fraises + disques</b> (6 fraises - 24 couteaux moyeux) - HEXAGONAL 23 mm
	Conjunto de fresas completo + discos laterais (6 fresas - 24 facas) - HEXAGONAL 23 mm
	9902 <b>Conjunto de fresas completo + discos</b> (8 fresas - 32 cuchillas) - HEXAGONAL 32 mm
	Juego de fresas completo + discos (8 fresas - 32 cuchillas) - HEXAGONAL 32 mm
	9902 <b>Jeu de fraises + disques</b> (8 fraises - 32 couteaux moyeux) - HEXAGONAL 32 mm
	Conjunto de fresas completo + discos laterais (8 fresas - 32 facas) - HEXAGONAL 32 mm
	9902 <b>Conjunto de fresas completo + discos</b> (8 fresas - 32 facas) - HEXAGONAL 32 mm

**HL7T520**



**HLV8T1040**





	HL7T520	HLV8T1040
230V- 50Hz	2300 W	3000 W
	5 - 32cm	8 - 30
	20-52cm	10-55 cm
	7 Tn	8 Tn
	6,5 L	4,0 L
	76dB(A)	89,7dB(A)
	1090x310x560	585x435x1055
Peso Poids Peso (Kg)	87	110
Código Code Código	<b>9096N</b>	<b>9097N</b>

**ACCESORIOS OPCIONAL / ACCESSOIRES OPTIONNEL / ACESÓRIOS OPCIONAI**

		
Código Code Código	<b>33475</b>	<b>33476</b>
	7 TN	8 TN



**SB3500-60**



	<b>SB3500-60<sup>(1)</sup></b>
230V- 50Hz	3500 W
	1400 RPM
	Z56 600mm WIDIA
	mín. 10 cm máx. 19cm
	115dB(A)
	1150x900x1200
Peso Poids Peso (Kg)	101
Código Code Código	<b>9565</b>





<sup>(1)</sup> SOLO HASTA FIN DE STOCKS  
STOCKS RÉDUITS  
SÓ ATÉ O FIM DAS EXISTÊNCIAS

**DISCOS WIDIA / DISQUES WIDIA / DISCOS WIDIA**

	Código Code Código		<b>Z</b>	
	<b>33489<sup>(1)</sup></b>	600mm x 30mm x 4,2mm	56	<b>SB3500-60</b>

NEA 560E



	NEA 560E	NEA TJ45E	T-160 HO
Tipo Type Serie	2T	2T	4T
Motor Moteur Motor	BB N55E	KAWASAKI TJ45E	HONDA GCV-160
 kW	1,8	1,4	3,3
 cm <sup>3</sup>	53,2	45,4	160
 MAX	250mm	250mm	400mm
 MAX	1,6m	1,4m	2,0m
	-	-	✓
	1	1	2
 mm	440 x 540 x 360	440 x 540 x 360	660 x 430 x 550
Peso Poids Peso (Kg)	10,7	10,2	27
Código Code Código	9981	8451	9905



T-160 HO



NEA TJ45E



Todas las máquinas se sirven sin barrena, la cual deberá ser pedida aparte.  
Les tarières sont fournies sans la mèche, qui doit être commandée séparément.  
Todas as maquinas são entregues sem brocas, devem-se pedir a parte.

		Referencia Réference Referência	Ø (mm)	L (mm)	
	NEA	510081	80	800	
		510082	100	800	
		510083	120	800	
		510084	150	800	
		510085	180	800	
		510086	200	800	
		511972	250	800	
		T-160	510094	100	700
			510095	150	700
			510096	200	700
			510097	250	700
			510098	300	700
			510099	350	700
			510100	400	700
510108			100	1000	
510109			150	1000	
510110			200	1000	
510111			250	1000	
510112			300	1000	
510113			350	1000	
510114			400	1000	

### EXTENSIONES BARRENAS (sin espiral)

RALLONGES DE MECHEs (sans spirale) PROLONGADOR DE BROCAS (sem espiral)

		Referencia Réference Referência	L (mm)
	NEA	510115	400
	T-160	510117	500
510118		1000	

### PUNTAS BARRENA (acero templado)

BOUTS MECHEs (acier trempé) PONTAS BROCAS (aço temperado)

		Referencia Réference Referência
	NEA	510134
	T-160	510135

### CUCHILLAS EXCAVADORAS (acero templado)

COUTEAUX EXCAVATEURS (acier trempé) LÂMINAS ESCAVADORAS (aço temperado)

		Referencia Réference Referência	Ø (mm)
	NEA T-160	510126	80
		510974	100
		510989	120
		510128	150
		510990	180
		510129	200
		510130	250
		510131	300
		510132	350
		510133	400

		Referencia Réference Referência
Tornillo Vis Parafuso		510206
Tuerca Ecrou Porca		510211

### BX-52



### CX-2843 - CX-2852



**CAMPEON**

**CX-2843**

Engine displacement: 42.7cc  
 Max engine power: 1.25kw/7500rpm  
 Engine idling speed: 3000±300 min<sup>-1</sup>  
 Fuel Mixture: Petrol 40 : Oil 1  
 Volume of fuel tank: 0.9L  
 Weight: 7.3 kg

e9\*2016/1628\*2016/1628SHA1/P\*1207\*00

113dB

CE

C/ Galileo 2, Pol'gono Industrial Autopista Nave 3  
 08150 Parets del Vallès (Barcelona) - ESPAÑA  
 www.campeon.es

**CAMPEON**

**CX-2852**

Engine displacement: 51.7cc  
 Max engine power: 1.75kw/7500rpm  
 Engine idling speed: 3000±300 min<sup>-1</sup>  
 Fuel Mixture: Petrol 40 : Oil 1  
 Volume of fuel tank: 0.9L  
 Weight: 7.8 kg

e9\*2016/1628\*2016/1628SHB1/P\*1209\*00

113dB

CE

C/ Galileo 2, Pol'gono Industrial Autopista Nave 3  
 08150 Parets del Vallès (Barcelona) - ESPAÑA  
 www.campeon.es

	BX-52	CX-2843	CX-2852
Tipo Type Serie	2T	2T	2T
cm³	51,7	42,7	51,7
kW	1,75	1,25	1,75
	7500	7500	7500
	850ml	900ml	900ml
	Ø 26mm x 750mm	Ø 28mm x 1500mm	
	✓	-	-
	✓	✓	✓
	✓	✓	✓
	AUTOMATIC 2,4mm	AUTOMATIC 2,4mm	AUTOMATIC 2,4-3,5mm
	42cm	43cm	
	25,5cm	255 X 2mm	
	114dB(A)	113dB(A)	
	1550 x 105 x 100 + 320 x 300 x 590	1850 x 300 x 285	
Peso Poids Peso (Kg)	11	7,3	7,8
Código Code Código	<b>9362</b>	<b>9360</b>	<b>9361</b>

Todas las desbrozadoras se entregan con cabezal de hilo y disco de corte.  
 Les débroussailleuses sont livrées de série avec outil à fil et outil métal.  
 Todas as roçadoras são entregues com cabeça de fio e discos de corte.

### ACCESORIOS OPCIONAL / ACCESSOIRES OPTIONNEL / ACESÓRIOS OPCIONAI

#### CX-2843 / CX2852

Código Code Código	<b>33730</b>	<b>33731</b>



## CBC-251 PREMIUM



NEW

## MULTIFUNCION TX-MT5080



NEW

	CBC-251 PREMIUM	MULTIFUNCION TX-MT5080
Tipo Type Serie	2T	2T
Motor Moteur Motor	1E43F-B	1E43F-B
kW	1,56 KW	1,56 KW
	7500 rpm	7500 rpm
cm <sup>3</sup>	50,8	50,8cc
	800ml	800 ml
	28mm x 1500mm	26mm x 1080mm
	✓	✓
	✓	✓
	AUTOMATIC 2,5mm	AUTOMATIC 2,4-3,5mm
	42 cm	42 cm
	25,5cm	25,5cm
	-	28
	-	40
	-	3/8"
	-	30
		CAMPEON
		44
		EXTENSION 95 CM
	117dB (A)	117dB (A)
	1850x280x285/105	1070x335/1005x300
Peso Poids Peso (Kg)	9,8	14,20 kg / 18,20 Kg c/accesorios
Código Code Código	9343	9380

Todas las desbrozadoras se entregan con cabezal de hilo y disco de corte.

Les débroussailleuses sont livrées de série avec outil à fil et outil métal.

Todas as roçadoras são entregues com cabeça de fio e discos de corte.

### ACCESORIOS OPCIONAL / ACCESSOIRES OPTIONNEL / ACESÓRIOS OPCIONAL

	<b>CBC-251 PREMIUM / MULTIFUNCION TX-MT5080</b>	
Código Code Código	33730	33731

## CBC-245/253 PRO



## CBC 250 PRO



	CBC-245 PRO	CBC-253 PRO	CBC-250 PRO
Tipo Type Serie	2T	2T	2T
Motor Moteur Motor	KAWASAKI TJ45E	KAWASAKI TJ53E	HONDA GX50
kW	1,42	2,00	1,47
	7500	8500	7000
cm <sup>2</sup>	45,4	53,2	47,9
	900ml	1100ml	630ml
	Ø 28mm x 1500mm		
	✓	✓	✓
	✓	✓	✓
	AUTOMATIC 2,4mm		
	43cm		
	255 X 1,8mm		
	113dB(A)	112dB(A)	
	1870 x 310 x 290		
Peso Poids Peso (Kg)	8,9	9,4	9,3
Código Code Código	<b>9440</b>	<b>9445</b>	<b>9448</b>

Todas las desbrozadoras se entregan con cabezal de hilo y disco de corte.  
Les débroussailleuses sont livrées de série avec outil à fil et outil métal.  
Todas as roçadoras são entregues com cabeça de fio e discos de corte.

## ACCESORIOS OPCIONAL / ACCESSOIRES OPTIONNEL / ACESÓRIOS OPCIONAL

### CBC-245/253/250 PRO

Código Code Código	<b>511355</b>	<b>32475</b>

## SBC-28TJ45/53 LH800



### ACCESORIOS OPCIONAL / ACCESSOIRES OPTIONNEL / ACESÓRIOS OPCIONAI

#### SBC-28TJ35/45/53 LH800



Código Code Código

32474

32475



Código Code Código

91BLH

Motor Moteur Motor

KAWASAKI TJ

Tipo Type Serie

Ø28 mm x 1522 mm

	SBC-28TJ35 LH800 <sup>(1)</sup>	SBC-28TJ45 LH800	SBC-28TJ53 LH800
Tipo Type Serie	2T	2T	2T
Motor Moteur Motor	KAWASAKI TJ35E	KAWASAKI TJ45E	KAWASAKI TJ53E
kW	1,03	1,42	2,0
RPM	7000	7500	8500
cm <sup>2</sup>	34,4	45,4	53,2
Fuel	700 ml	900 ml	1100 ml
Head	Ø28 mm x 1522 mm		
Battery	-	-	-
Head	✓	✓	✓
Head	✓	✓	✓
Head	Automatic 2,4 mm	Automatic 2,4 mm	Automatic 2,4 mm
Head	42 cm	42 cm	42 cm
Head	30,5 cm	30,5 cm	30,5 cm
Head	114 dB(A)	114 dB(A)	114 dB(A)
Head	1700x225x140 + 320x310x210		
Peso Poids Peso (Kg)	8,1	9,7	10,3
Código Code Código	9135LH	9145LH	9183LH

Todas las desbrozadoras se entregan con cabezal de hilo y disco de corte.

Les débroussailleuses sont livrées de série avec outil à fil et outil métal.

Todas as roçadoras são entregues com cabeça de fio e discos de corte.

(1) SOLO HASTA FIN DE STOCKS / STOCKS RÉDUITS / SÓ ATÉ O FIM DAS EXISTÊNCIAS

**STB-2627**



**BP-260**



**SBC-28TJ45**



**SBC-2835**



	STB-2627 <sup>(1)</sup>	BP-260	SBC-28TJ35 <sup>(1)</sup>	SBC-28TJ45	SBC-28TJ53	SBC-2835
Tipo Type Serie	2T	2T	2T	2T	2T	4T
Motor Moteur Motor	KAWASAKI TJ27E	KAWASAKI TJ53E	KAWASAKI TJ35E	KAWASAKI TJ45E	KAWASAKI TJ53E	HONDA GX35
kW	0,77	2,7	1.03	1,42	2,0	1,0
	7500	7500	7000	7500	8500	7000
	26,3	53,2	34,4	45,4	53,2	35,8
	500ml	1000ml	700 ml	900 ml	1100 ml	630 ml
	Ø 26mm x 1500mm	Ø 26mm x 750mm	Ø28 mm x 1540 mm			
	✓	✓	-	-	-	-
	-	-	✓	✓	✓	✓
	✓	-	✓	✓	✓	✓
	Automatic 2,4 mm					
	42 cm					
	25,5 cm					
	109dB(A)	114dB(A)	114 dB(A)	114 dB(A)	114 dB(A)	108 dB(A)
	1700x225x140 + 320x310x210	1630x120x120 + 600x120x120	1700 x 225 x 140 + 320 x 310 x 210			
Peso Poids Peso (Kg)	5,9	11,8	8,1	9,7	10,3	9,13
Código Code Código	<b>8422</b>	<b>8587</b>	<b>9135</b>	<b>9145</b>	<b>9183</b>	<b>8426</b>

Todas las desbrozadoras se entregan con cabezal de hilo y disco de corte.  
Les débroussailleuses sont livrées de série avec outil à fil et outil métal.  
Todas as roçadoras são entregues com cabeça de fio e discos de corte.

**(1) SOLO HASTA FIN DE STOCKS / STOCKS RÉDUITS / SÓ ATÉ O FIM DAS EXISTÊNCIAS**

**ACCESORIOS OPCIONAL  
ACCESSOIRES OPTIONNEL / ACESÓRIOS OPCIONAL**

**STB / BP / SBC**

Código Code Código	<b>32474</b> <b>32475</b>



Código Code Código	<b>8502</b>	<b>91B</b>
Motor Moteur Motor	HONDA GX	KAWASAKI TJ
Tipo Type Serie	Ø28 mm x 1540 mm	

## CABEZALES DE HILO DE NYLON • OUTILS DE COUPE A FILS NYLON • CABEÇAS DE NYLON

	Ref. 511931		Ref. 511924		Ref. 511550		Ref. 511549
	Ref. 511699		Ref. 510079		Ref. 511918		Ref. 511110 Ø 26-28 mm

## CABEZALES DE HILO DE NYLON • OUTILS DE COUPE A FILS NYLON • CABEÇAS DE NYLON

	Ref. 510004	Ref. 510005	Ref. 510006
	M 8 X 1,25 (H) D=120 mm	M 10 X 1 (H) D=120 mm	M 10 X 1,25 (H) D=120 mm

	Ref. 32519B
---	-------------

	Ref. 511354	Ref. 511355	Ref. 32474
	M 8 X 1,25 (H) D=127 mm	M 10 X 1 (H) D=127 mm	M 10 X 1,25 (H) D=110 mm

	Ref. 32587 - carga rápida
	M10X1 + M10X1,25(H) D=130mm >33cm3>1,015hp

## CUCHILLAS/DISCOS/SIERRAS • COUPEAU/DISQUES/SCIÉS • LÂMINAS/DISCOS/SERRAS

	Ref. 510018	Ref. 510020	Ref. 510994
	Ø 255 mm	Ø 300 mm	Ø 305 mm
	E = 1,6 mm	E = 1,8 mm	E = 3 mm
	Acero/Acier/Aço	Acero/Acier/Aço	BUSATIS

	Ref. 32556	Ref. 32583
	Ø 305 mm	Ø 305 mm
	E = 3 mm MULCHING	E = 4 mm MULCHING
	Acero/Acier/Aço	Acero/Acier/Aço

	Ref. 32475	Ref. 510027	Ref. 510028
	Ø 255 mm	Ø 300 mm	Ø 255 mm
	E = 1,4 mm	E = 3 mm	E = 3 mm
	Acero/Acier/Aço	Acero/Acier/Aço	NYLON
	P.V.P 7,90€	P.V.P 12,00€	P.V.P 2,30€

	Ref. 510031	Ref. 510033
	Ø 255 mm	Ø 255 mm
	E = 1,8 mm	E = 3 mm
	Acero/Acier/Aço	NYLON

	Ref. 510042
	Ø 255 mm
	E = 1,4 mm
	D = 80
	Acero/Acier/Aço

	Ref. 32584	Ref. 32517	Ref. 32555
	Ø 255 mm	Ø 255 mm	Ø 255 mm
	E = 1,3 mm	E = 1,4 mm	E = 2 mm
	D = 40	D = 20	D = 36
	WIDIA PRO	WIDIA	WIDIA PRO

## NYLON • NYLON • NYLON

	Ref.	
	Ø 1,6 mm - 180 m	511685
	Ø 1,6 mm - 750 m	518002
	Ø 2,0 mm - 15 m	511686
	Ø 2,0 mm - 130 m	510062
	Ø 2,0 mm - 520 m	510063
	Ø 2,4 mm - 90 m	510065
	Ø 2,4 mm - 360 m	510066
	Ø 3,0 mm - 60 m	510068
	Ø 3,0 mm - 240 m	510069
	Ø 3,3 mm - 50 m	510071
	Ø 3,3 mm - 210 m	510072
	Ø 4,0 mm - 35 m	511691
	Ø 4,0 mm - 150 m	511692

	Ref.	
	Ø 2,4 mm - 15 m	511693
	Ø 2,4 mm - 60 m	511694
	Ø 2,4 mm - 345 m	518003
	Ø 3,0 mm - 15 m	511941
	Ø 3,0 mm - 40 m	511696
	Ø 3,0 mm - 232 m	518004
	Ø 4,0 mm - 9 m	518000
	Ø 4,0 mm - 25 m	518001
	Ø 4,0 mm - 110 m	518005

## TCS-2600



## TCS-4600



**DESCOMPRESOR PARA FÁCIL ARRANQUE**  
Descompresor  
Décompresseur  
Descompressor

## TCS-5600



**DESCOMPRESOR PARA FÁCIL ARRANQUE**  
Descompresor  
Décompresseur  
Descompressor

## HT-3401

**NEW**



	TCS-2600	TCS-4600	TCS-5600	HT-3401
Tipo Type Serie	2T	2T	2T	2T
Motor Moteur Motor	-	-	-	1E34F-6
kW	0,9	1,8	2,4	0,75
MINIMA MAXIMA	3000 +- 300 11000	3100 +- 300 11000	3100 +- 300 11000	7.500
cm <sup>3</sup>	25,4	45,02	56	24,4
				-
	230ml	550ml	550ml	400 ml
	160ml	260ml	260ml	-
cm	25	45	50	-
	3/8"	0,325	0,325	-
	CAMPEON	OREGON	OREGON	-
	40	72	78	28
	-	-	-	5 posiciones 5 positions 5 posições
OIL AUTOMATIC	✓	✓	✓	-
	✓	✓	✓	-
Descompresor Décompresseur Descompressor	-	✓	✓	-
	300x260x260	530x275x320		1175x263x290
Peso Poids Peso (Kg)	3,2	5	5,2	6,3
Código Code Código	9114	9116	9117	9982

### ACCESORIOS OPCIONAL / ACCESSOIRES OPTIONNEL / ACESSÓRIOS OPCIONAL

	TCS-2600	TCS-4600	TCS-5600
Código Code Código	204205	204207	204207
	25-36 cc	45-50 cc	45-50 cc
Código Code Código	100SDEA041	188PXBK095	208PXBK095
Código Code Código	91PJ040X	21BPX072X	21BPX078X

### KIT CARVING (ESPADA + CADENA + PIÑÓN)

Código Code Código	33653
--------------------	-------

4GS-50(26)



4GS-50

SIN MOTOR, SOLO ACCESORIO  
SANS MOTEUR, SEUL ACCESSOIRE  
SEM MOTOR, APENAS ACESÓRIO

PULSAR STD



PULSAR STD TELESCOPIC

	4GS-50(26)(1)	4GS-50(1)	PULSAR STD	PULSAR STD TELESCOPIC
Tipo Type Serie	2T	-	-	-
Motor Moteur Motor	1E34F-2E	-	-	-
kW	0,7	-	-	-
	7500	-	-	-
cm <sup>3</sup>	25,4	-	-	-
	650mL	-	-	-
	-	-	12v	12v
	-	-	3200 (1600+1600)	3200(1600+1600)
	300/500mm	300/500mm	280mm	280mm
	1500 x 26 mm	750 x 2mm	2300mm + 1000mm	1850mm/2750 + 1000m
	8	8	10	10
	-	-	15m	15m
	-	-	60/80 Ah	60/80 Ah
mm	1750x265x165 + 620x350x100	610x335x93	24x17x220cm	24x17x220cm
Peso Poids Peso (Kg)	7,9	5,4	2,6	2,6
Código Code Código	7647	7529	8955	8956

<sup>(1)</sup> Nueva versión con doble leva  
Nouvelle version avec double came  
Nova versão com cam dupla

**MD320SH**



ITALIAN DESIGN



**C100KGA**



	<b>MD-320SH</b>	<b>C100KG-A</b>
	-2 -1 0 +1 +2 +3 +4 +5 +6	-1 0 +1
	-2,3 a -0,6 / 0,5 a 4,9	-2,0 / 3,6
<b>Transmisión</b> <b>Transmission</b> <b>Trasmissoao</b>	Correa y engranajes <b>Courroie et engrenages</b> <b>Correia e por pinhão</b>	
<b>Motor Moteur Motor</b>	ECO-210	BRIGGS&STRATTON BS450E
<b>kw</b>	4,4	2,61
<b>cm³</b>	212	125
	Manual <b>Manuel</b> Manual	
	3,6 L	0,8 L
	3 h	1 h
	320	100
	25°	15°
	15° - 150 Kg	15° - 75 Kg
<b>m (min)</b>	2,3	-
<b>mm</b>	850x570x290	85 L
<b>mm</b>	1000x740x290	-
	60° (manual)	60° (manual)
<b>mm</b>	340	-
	1620 x 600 x 830	1435 x 705 x 910
<b>mm</b>	1350 x 750 x 910	1100 x 650 x 700
	97 dB (A)	94 dB (A)
<b>Peso Poids Peso (Kg)</b>	156	63
<b>Código Code Código</b>	<b>9140</b>	<b>9338</b>



MD-500



MD-500H



	MD-500	MD-500H
	-1 0 +1 +2 +3	-1 0 +1 +2 +3
	-2,1 / 2,3 a 4,8 km/h	-2,1 / 2,3 a 4,8 km/h
Transmisión Transmission Trasmisao	Correa y engranajes Courroie et engrenages Correira e por pinhão	
Motor Moteur Motor	ECO 210	ECO 210
kW	4,4	4,4
cm <sup>3</sup>	212	212
	Manual Manuel Manual	
	3,6 L	3,6 L
	3 h	3 h
	500	500
	25°	25°
	15° - 235 Kg	15° - 235 Kg
	1,15	1,15
mm	1190x765x300	1190x765x300
mm	1340x915x300	1340x915x300
	60° (manual)	50° (hidraulico)
mm	420	420
	2035 x 890 x 1190	2035 x 890 x 1190
mm	1650 × 1000 × 1100mm	1650 × 1000 × 1100mm
	101 dB (A)	101 dB (A)
Peso Poids Peso (Kg)	274	301
Código Code Código	9263	9264

CS22-04



NEW

PCS22-10



NEW

	CS22-04	PCS22-10
	10,8V-12,6V max	18V-21V max (250W)
	x2 Lithium	Lithium
<b>AMP</b>	2.5 Ah	5 Ah
Motor <i>Moteur</i> Motor	Brushless	
	10 cm (4")	17,5 cm (7")
	100 mm	175 mm
	-	176 cm - 257 cm
	1/4"	1/4"
	29	48
	2-2,5 h	2 h
Peso <i>Poids</i> Peso (Kg)	1,0	3,35
	440X220X150	160x12x12
Código <i>Code</i> Código	<b>9469</b>	<b>8965</b>

ACCESORIOS OPCIONALES PARA CS22-04  
ACCESSOIRES OPTIONNELS POUR CS22-04  
ACESÓRIOS OPCIONAIS PARA CS22-04

Prolongación telescópica EP22-22  
(cerrada: 120 cm extendida : 200 cm)

Código *Code* Código **94691**



2 baterías necesarias (1 para CS22-04 + 1 para EP22-22)  
2 batteries nécessaires (1 pour CS22-04 + 1 pour EP22-22)  
2 baterias necessárias (1 para CS22-04 + 1 para EP22-22)

CS 22-06



THCS 22-10



SG 22-10



	CS 22-06	THCS 22-10	SG 22-10
	14,4-16,8V max	18-21V max	10,8-12,6V max
	x2 Lithium	x2 Lihium	Lihium
<b>AMP</b>	2.5 Ah	5 Ah	2.5 Ah
Motor <i>Moteur</i> Motor	Brushless		
	12,5 cm (5")	17,5 cm (7")	-
	125 mm	175 mm	-
	1/4"	1/4"	-
	34	48	-
	1,5- 2 h	2 -2,5 h	2 -2,5 h
	-	-	10 bar
	-	-	1 L
	3 Modos <i>3 modes</i> 3 modos		
	440 x 220 x150	380 x 300 x 200	360 x 140 x260
Peso <i>Poids</i> Peso (Kg)	1.4 kg	2.5 kg	0.9 kg
Código <i>Code</i> Código	<b>8963</b>	<b>8964</b>	<b>8962</b>



CM-25



CM-32



CL-25



	CM-25	CM-32	CL-25
	14,4-16,8V max	14,4-16,8V max	14,4-16,8V max
	x2 Lithium	x2 Lithium	x2 Lithium
<b>AMP</b>	2,5 Ah	2,5 Ah	2,5 Ah
	1,5-2	1,5-2	1,5-2
	3-4h	3-4h	3-4h
	DISPLAY	DISPLAY	DISPLAY
	Progresivo progressive progressivo		-
	17-25mm	25-32mm	-
	Piñon + Corona/ Pignon + Couronne/ Pinhão + Coroa		-
	✓	✓	-
	-	-	4
	-	-	25 mm
	-	-	2 x 90 mm
	370 x 270 x 90	370 x 270 x 90	370 x 270 x 90
Peso Poids Peso (Kg)	920 gr	940 gr	1065 gr
Código Code Código	<b>9350</b>	<b>9378</b>	<b>9351</b>

ACCESORIOS OPCIONALES PARA CL-25  
ACCESSOIRES OPTIONNELS POUR CL-25  
ACESÓRIOS OPCIONAIS PARA CL-25

Código Code Código

**33603**



**CP650**



3 m³/h

10 cm

**CP1500 E-START**



4 m³/h

12 cm

	CP650	CP1500 E-START
Tipo Type Serie	4T	4T
Motor Moteur Motor	G200F	G420F(D)
RPM	2400	2000
Arranque Démarrage Iniciar	Manual Manuel Manual	Eléctrico Électrique Eléctrico
cm³	196	420
	-	Incluída Inclus Include
	100mm verde/ 60mm seco	120mm verde/ 80mm seco
	110dB(A)	
	555x850x870	1800x800x1150
Peso Poids Peso (Kg)	90	192
Código Code Código	<b>9138</b>	<b>9139</b>

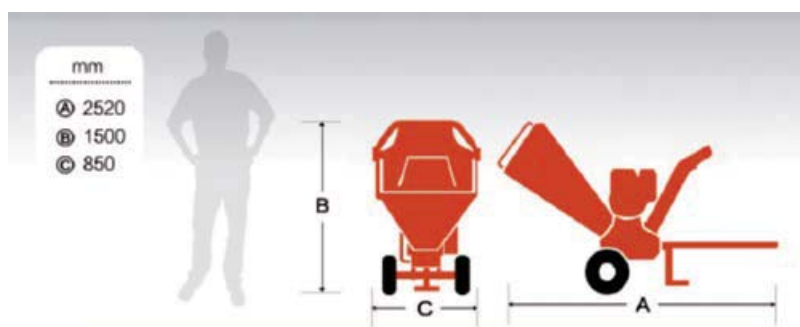
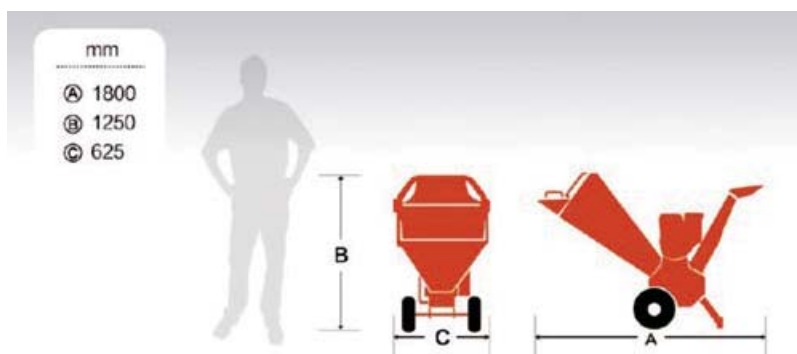
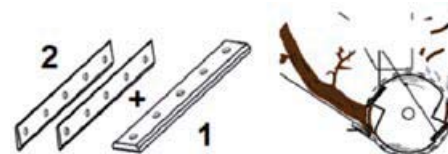

**CM-90**



**CM-210**



**CM-150RG**



	CM-90	CM-210	CM-150 RG
Motor <i>Moteur</i> Motor	LONCIN LC1P65FE-3	LONCIN LC1P65FE	LONCIN LC1P70FE-3
	2500	2600	2600
	123	139	196
	2,2	2,7	3,8
	✓	✓	-1,0+1
Transmisión <i>Transmission</i> Trasmissoao	Correa y engranajes <i>Courroie et engrenages</i> <i>Correia e por pinhão</i>		
	87 MULCHING	87 MULCHING BI-LAMA	53
	-	-	50/80
	Regulable <i>Réglage variable</i> Regulavel		
	13x5.00-6	13x5.00-6	13x6.00-6
	-	-	-3,3/+2,5
	99,4 dB (A)	94,2 dB (A)	97,2 dB (A)
Peso <i>Poids</i> Peso (Kg)	54	57	55
Código <i>Code</i> Código	<b>9339</b>	<b>7413</b>	<b>9225L</b>

**ACCESORIOS OPCIONALES PARA CM-150 RG**  
**ACCESSOIRES OPTIONNELS POUR CM-150 RG**  
**ACESÓRIOS OPCIONAIS PARA CM-150 RG**

Ancho trabajo 57cm, 4 cuchillas pivotantes altura de corte 32 mm  
*Largeur de travail 57cm, 4 lames pivotantes hauteur de coupe 32 mm*  
*Largeza de trabalho 57cm, 4 lâminas pivotantes com altura de corte de 32 mm*

Código <i>Code</i> Código	<b>8220</b>
Peso <i>Poids</i> Peso (Kg)	27 Kg

**NEW**



# HIDROLIMPIADORAS

## NETTOYEURS HAUTE-PRESSION

### MÁQUINAS DE LAVAR DE ALTA PRESSÃO

#### CKRM-1100 CLASSIC



**NEW**

#### CKRS-1300 EXTRA



**NEW**



ENROLLADOR Y MANGUERA INCLUIDOS  
ROULEAU ET TUYAU INCLUS  
ROLO E MANGUEIRA INCLUIDA



DEPÓSITO DE DETERGENTE 0,7 L INCLUIDO  
(SOLO EN CKRS-1300 EXTRA)  
DÉPOT DE DÉTERGENT DE 0,7 L INCLUS  
(SEULEMENT SUR CKRS-1300 EXTRA)  
0,7 L DEPÓSITO DE DETERGENTE INCLUIDO  
(SOMENTE EM CKRS-1300 EXTRA)

#### ACCESORIOS / ACCESSOIRES / ACESÓRIOS

  Opcional En option Opcional   Standard

	CKRM-1100 CLASSIC	CKRS-1300 EXTRA
MAX	125 Bar	150 Bar
	2800	2800
	Monofásico <b>Monophasé</b> Monofásica 50Hz-230V	
kw	1,75	2,35
MAX	360 l/h	500 l/h
MAX	40°	40°
	Aluminio <b>Aluminium</b> Aluminio	
Detergente Détergent Detergente	-	0,7 L
LWA	96 dB(A)	94 dB(A)
EASY-START	✓	✓
<b>TOTAL STOP</b>	✓	✓
	295 x 265 x 600	380 x 300 x 570
Peso Poids Peso (Kg)	7,1	8,6
Código Code Código	<b>9381</b>	<b>9382</b>

	CKRM-1100 CLASSIC		CKRS-1300 EXTRA	
	Kit pistola 24100239	6080049		Kit pistola 24100239  6080049
	Lanza 33011501	Racor 3/4 50020024		Lanza 33011501  Racor 3/4 50020024
	° 0,95 32170350	14130057		° 1,00 32170350  14130059
	° 1,025 32170340	14130059		° 1,025 32170340  10 m 30450061
	lanza espumosa 33011510	10 m 30450061		8 m 32081345  6 m 33011505
	6 m 32081343	6 m 33011505		14130057  33011503 ° 1,2
	33011503 ° 1,2			

# HIDROLIMPIADORAS

## NETTOYEURS HAUTE-PRESSION

### MÁQUINAS DE LAVAR DE ALTA PRESSÃO

#### CKSM 1480 GOLD EXTRA



#### CKS 1700 GOLD EXTRA



ENROLLADOR Y MANGUERA INCLUIDOS  
ROULEAU ET TUYAU INCLUS  
ROLO E MANGUEIRA INCLUIDA

DEPÓSITO DE DETERGENTE 1,8 L INCLUIDO (SOLO EN CKS 1700 GOLD EXTRA)  
DÉPÔT DE DÉTERGENT DE 1,8 L INCLUS (SEULEMENT SUR CKS 1700 GOLD EXTRA)  
1,8 L DEPÓSITO DE DETERGENTE INCLUIDO (SOMENTE EM CKS 1700 GOLD EXTRA)

	CKSM 1480 GOLD EXTRA	CKS 1700 GOLD EXTRA
MAX	150 Bar	155 Bar
	2800	2800
	Monofásico	Monofásico 50Hz-230V
kW	2,3	2,7
MAX	480 l/h	540 l/h
MAX	40°	40°
	Latón Laiton Bronze	
Detergente Détergent Detergente	-	1,8 L
LWA	78 dB(A)	78 dB(A)
EASY-START	✓	✓
	✓	✓
	890x320x380	820x308x310
Peso Poids Peso (Kg)	20	19
Código Code Código	9403	9406

#### ACCESORIOS / ACCESSOIRES / ACESÓRIOS

Opcional En option Opcional Standard

	CKSM 1480	CKS 1700		CKSM 1480	CKS 1700		CKSM 1480	CKS 1700
	24100097	-		-	Ø 1,25 34000510		8 m 30450028	8 m 30450028
	33010801	-		-	Ø 1,25 33011052		15 m 30450029	15 m 30450029
	33010804	-	TURBO				8 m - R1 1/4" 33010811	8 m - R1 1/4" 33010811
	33010795	33010795		33010801	33010801		GH281-REG 24100246	GH281-REG 24100246
	10 m - 1/4" 33010806	10 m - R1/4" 33010794		14130032	14130032		1-10 Bar 06080049	1-10 Bar 06080049
	-	GC250 24100118		14130033	14130033			
	-	Ø 1,25 33011064		33011008	33011008			
	-			33010710	33010710			



# HIDROLIMPIADORAS

## NETTOYEURS HAUTE-PRESSION

### MÁQUINAS DE LAVAR DE ALTA PRESSÃO

#### CKA 3200



(\*) **MODELO EXCEL**  
**Opcional bajo pedido**  
 En option sur demande  
 Opcional mediante solicitação

#### CKA 3200 CLASSIC

MAX	150 Bar
	2800
	Monofásico <b>Monophasé</b> Monofásica 50Hz-230V
kW	2,9
MAX	600 l/h
MAX	40°
	Latón <b>Laiton</b> Bronze
Detergente Détergent Detergente	4 L
LWA	78 dB(A)
EASY-START	✓
<b>TOTAL STOP</b>	✓
	940x440x420
Peso <b>Poids</b> Peso (Kg)	36
Código <b>Code</b> Código	<b>9414</b>

#### CKA 3200

	24100120		GH 281 24100227		25 m 30450041		33010766
	500 mm 33010935		TURBO 33011052		8 m - R1 1/4" 33010769		700 mm 33010941
	8m - R1 1/4" 32081012		33010771		33010710		1/4" -25° 34000391
	1/4" -15° 34000709		14130029		1-10 Bar 06080049		15m (*) 70020241

#### ACCESORIOS / ACCESSOIRES / ACESÓRIOS

Opcional **En option** Opcional Standard

(\*) **SOLO VÁLIDO PARA CKA 3200 EXCEL**

UNIQUEMENT VALIDE POUR LA VERSION CKA 3200 EXCEL  
 VÁLIDO APENAS PARA VERSÃO CKA 3200 EXCEL

# HIDROLIMPIADORAS

## NETTOYEURS HAUTE-PRESSION

### MÁQUINAS DE LAVAR DE ALTA PRESSÃO

CX2



CX4 16/260



	CX2 12/200	CX2 13/150	CX2 16/250	CX4 16/260
MAX	200 Bar	150 Bar	250 Bar	260 Bar
BOMBA	3400	3400	3400	1560
	G200F	HONDA GX-160	HONDA GX-390	HONDA GX-390
kW	4,1	5,5	13	13
MAX	720 l/h	780 l/h	960 l/h	960 l/h
MAX	55°	55°	55°	55°
	Latón Laiton Bronze			
	-	-	-	✓
LWA	106 dB(A)	106 dB(A)	106 dB(A)	107 dB(A)
EASY-START	✓	✓	✓	✓
	670 x 550 x 890	670 x 550 x 890	560 x 710 x 890	950 x 680 x 950
Peso Poids Peso (Kg)	30	30	50	72
Código Code Código	<b>9259</b>	<b>9410</b>	<b>9412</b>	<b>94131</b>

	CX2 12/200	CX2 13/150	CX2 16/250	CX4 16/260		CX2 12/200	CX2 13/150	CX2 16/250	CX4 16/260
	GC251 24100120	GH401 24100277	GH401 24100277	GH401 24100277		33010801	33010772	33010772	33010772
	500mm 33010935	700 mm 33010976	700 mm 33010976	33010976		14130033	14130030	14130030	14130030
DOBLE	-	700 mm 33010941	700 mm 33010941	-		33010901	33010901	33010901	33010901
	1/4"-15° 34000715	Ø 1,35 - 25° 34000705	Ø 1,35 - 15° 34000717	Ø 1,35 - 15° 34000693		25 m 30450041	25 m 30450041	25 m 30450036	25 m 30450036
	1/4"-25° 34000391	Ø 1,35-25° 34000705	Ø 1,35-15° 34000717	Ø 1,35-15° 34000391		8m - R1 1/4" 33010769	10 m - R1 5/16" 33010774	10 m - R2 5/16" 33010985	10 m - R2 5/16" 33010985
	8 m - R1 1/4" 32081012	8 m - R1 1/4" 32081012	10 m - R1 5/16" 33010776	10 m - R2 5/16" 33010776		20 m - R11/4" 70020236	20 m - R11/4" 70020236	15 m - R2 5/16" 70020237	15 m - R2 5/16" 70020441
TURBO	33011052	33010893	33010782	33010782		12150354	12150354	12150355	GH401 12150355

#### ACCESORIOS / ACCESSOIRES / ACESÓRIOS

Opcional En option Opcional

Standard

# HIDROLIMPIADORAS

## NETTOYEURS HAUTE-PRESSION

### MÁQUINAS DE LAVAR DE ALTA PRESSÃO

**CS 150**



**CS 150 EXTRA**

MAX	150 Bar
	2800
	Monofásico <b>Monofasé</b> Monofásica 50Hz-230V
kW	2,7
MAX	540 l/h
MAX	90°
	Latón <b>Laiton</b> Bronze
Detergente Détergent Detergente	✓
	✓
	3,11 Kg/h
LWA	84 dB(A)
EASY-START	✓
<b>TOTAL STOP</b>	✓
	890x500x820
Peso <b>Poids</b> Peso (Kg)	85
Código <b>Code</b> Código	<b>9420</b>

#### ACCESORIOS / ACCESSOIRES / ACESÓRIOS

Opcional **En option** Opcional Standard

CS 150							
	24100096		GH281-REG 24100246		700 mm 33010941		8 m - R1 1/4" 33010811
	700 mm 33010787		TURBO 33010780		04 34000391		FILTRO 10020129
	01/4"-15° 34000709		33010766		8 m 30450028		1-10 Bar 06080049
	10 m - R1 1/4" 32081016		33010989		15 m 30450029		
	REGULABLE Ø 1,1 33011054		14130033		ANTI-CAL 06080047		

# HIDROLIMPIADORAS

## NETTOYEURS HAUTE-PRESSION

### MÁQUINAS DE LAVAR DE ALTA PRESSÃO

#### CKP PRO CLASSIC



	CKP PRO CLASSIC 10/150M	CKP PRO CLASSIC 12/200T
MAX	150 Bar	200 Bar
	1400	1400
	Monofásico Monophase Monofásica	Trifásico Triphasé Trifásica
kW	3	5,3
MAX	600 l/h	720 l/h
MAX	110°	110°
	Latón Laiton Bronze	
Detergente Détergent Detergente	3,5 L	3,5 L
	15 L	15 L
	3,5 Kg/h	4,2 Kg/h
LWA	92 dB(A)	92 dB(A)
EASY-START	✓	✓
	Retardado Temporisé Temporizado	
	940x620x840	940x620x840
Peso Poids Peso (Kg)	95	100
Código Code Código	9261	9262

#### ACCESORIOS / ACCESSOIRES / ACESÓRIOS

Opcional En option Opcional Standard

	CKP PRO CLASSIC 10/150M	CKP PRO CLASSIC 12/200T		CKP PRO CLASSIC 10/150M	CKP PRO CLASSIC 12/200T		CKP PRO CLASSIC 10/150M	CKP PRO CLASSIC 12/200T
	GH 281 24100227	GH 281 24100227	60° MAX	14130029	14130030	TURBO	33010777	33010777
	900 mm 33011587	900 mm 33011587		33010772	33010772	ANTI-CAL	06080047	06080047
	1/4"-15° 34000715	1/4"-15° 34000715		25 m 30450041	25 m 30450041	EXTRA	10 m R1-5/16" 33010774	10 m R1-5/16" 33010774
	10 m - R1-1/4" 32081050	10 m - R1-5/16" 33010987	DOBLE	700 mm 33010941	700 mm 33010941		04660055	04660055
	GH401 24100126	GH401 24100275		Ø4 34000391	Ø4 34000391			
	GH 401 24100124	GH 401 24100124		33010901	33010901			



# HIDROLIMPIADORAS

## NETTOYEURS HAUTE-PRESSION

### MÁQUINAS DE LAVAR DE ALTA PRESSÃO

#### CKM EXTRA



	CKM EXTRA
MAX	200 Bar
	1400
	Trifásico <b>Triphasé</b> Trifásica 50Hz-400V
kW	7
MAX	900 l/h
	85°-140°
	Latón <b>Laiton</b> Bronze
Detergente <b>Détergent</b> Detergente	3,5 L
	18 L
	2,5 L
	5,7 Kg/h
LWA	92 dB(A)
	✓
	Retardado <b>Temporisé</b> Temporizado
	950 x 620 x 850
Peso <b>Poids</b> Peso (Kg)	128
Código <b>Code</b> Código	<b>9429</b>

#### ACCESORIOS / ACCESSOIRES / ACESÓRIOS

Opcional **En option** Opcional

Standard

CKM EXTRA							
	GH-401 24100277		GH-401 24100130		33010772		Ø4 34000391
	700 mm 33010974		TURBO 33010782		REGULABLE 33010911		10 m - R2-5/16" 33010985
	1/4"-25° 34000703		33010901		25m 30450041		15m R2-5/16" 70020386
	10 m - R5/16" 33010776		60° MAX 14130030		700 mm 33010941		04660055
	GH-401 24100128						



**Campeon**

# HIDROLIMPIADORAS

## NETTOYEURS HAUTE-PRESSION

### MÁQUINAS DE LAVAR DE ALTA PRESSÃO

CFDX-EXTREME		
4 Ruedas D.300 mm Motor HONDA GX-690	4 Roues D.300 mm Moteur HONDA GX-690	4 Rodas D.300 mm Motor HONDA GX-690
1560 rpm Arranque eléctrico OIL ALERT	1560 rpm Démarrage électrique OIL ALERT	1560 rpm Arranque eléctrico OIL ALERT
Desacelerador automático EASY-START	Décelérateur automatique EASY-START	Desacelerador automático EASY-START
Filtro de agua inspeccionable fácilmente a la entrada de la bomba	Filtre à eau facilement inspectable à l'entrée de la pompe	Filtro de água facilmente inspecionável na entrada da bomba
Posibilidad de aspirar de depósito externo, sin conectar a la red hídrica (autoaspirante)	Possibilité d'aspirer du réservoir externe, sans se connecter au réseau d'eau (auto-amorçante)	Possibilidade de aspirar a partir do reservatório externo, sem conectar à rede de água (autoaspirante)

CODE	MODEL	MAX		WORK		l/h	HP	kg	(L x W x H) cm
		bar	MPa	bar	MPa				
9416	FDX Xtreme 15/500 Honda GX690	520	52	500	50	990	22.0	150	100 x 82 x 85
9391	FDX Xtreme 18/400 Honda GX690	415	41,5	400	40	1080	22,0	150	100 x 82 x 85
9415	FDX Xtreme 21/350 Honda GX690	360	36	350	35	1260	22,0	150	100 x 82 x 85
9389	FDX Xtreme 30/280 Honda GX690	280	28	270	27	1800	22.0	150	100 x 82 x 85
9388	FDX Xtreme 36/230 Honda GX690	230	23	220	22	2160	22,0	150	100 x 82 x 85
9383	FDX Xtreme 42/180 Honda GX690	180	18	170	17	2520	22,0	150	100 x 82 x 85

P.V.P A CONSULTAR / P.V.P À CONSULTER / P.V.P PARA CONSULTAR



#### ACCESORIOS INCLUIDOS • ACCESSOIRES INCLUS • ACESÓRIOS INCLUIDOS

	GH501 INOX 24100220
	INOX MAX 300/500 bar
	INOX - REG 33011401
	20 m M24 x 1,5
	80 mesh 10020241

# GRUPOS ELECTRÓGENOS

## GROUPES ÉLECTROGÈNES

### GRUPOS GERADORES DE ENERGIA

**G950i**



**LC2000i**



**LC3500i**



	<b>G950i</b>	<b>LC2000i</b>	<b>LC3500i</b>
Tipo Type Serie	4T	4T	4T
INVERTER	Monofásico Monophasé Monofásica 50Hz-230V		
KVA	0,7	1,8	3,3
MAX KVA	0,95	1,6	3,0
Cos $\varphi$	1	1	1
	4 h	4 h	14 h (50%)
	-	-	✓
4m	-	63,5 db	65 db
7m	54-59 dB	54-59 dB	52-61 dB
LWA	93 dB(A)	90 dB(A)	90 dB(A)
Motor Moteur Motor	139F	LC148F-2	170FD-3
KW	1	2,2	4,4
	Manual Manuel Manual	Eléctrico Électrique Eléctrico	
	5500	5000	3600
cm <sup>3</sup>	40	80	212
	2,1 L	4,2 L	13 L
	1	1	2
	✓	✓	✓
CC	12V - 4A	12V - 8,3A	12V - 10A
	-	✓	✓
<b>ALERT OIL</b>	✓	✓	✓
Disyuntor Disjoncteur Circuit breaker	Automático Automatique Automatic		
	-	✓	✓
	395x209x355	520x295x490	595x455x540
Peso Poids Peso (Kg)	8,5	21	45
Código Code Código	<b>9306</b>	<b>9370</b>	<b>9318</b>

# GRUPOS ELECTRÓGENOS

## GROUPES ÉLECTROGÈNES

### GRUPOS GERADORES DE ENERGIA

MK950

NEW



MK2500

NEW



MK3600

NEW



MK6500

NEW



MK6500T

NEW



	MK950	MK2500	MK3600	MK6500	MK6500T
Tipo Type Serie	4T	4T	4T	4T	4T
	Monofásico Monophasé Monofásica 50Hz-230V				Trifásico Triphasé Trifásica 50Hz-400V
	0,8	2	2,5	5	7
	0,9	2,2	2,8	5,5	7,5
cos φ	1	1	1	1	0,8
	9 h (50%)	12 h	12 h	9 h	9 h
	-	✓	✓	✓	✓
	✓	✓	✓	✓	✓
	✓	✓	✓	✓	✓
	89 dB(A)	93 dB(A)	93 dB(A)	97 dB(A)	97 dB(A)
Motor Moteur Motor	SPE80	SFE200	SFE200	SFE390	SFE390
	Manual Manuel Manual				
	1,7	4,1	4,1	8,2	8,2
	3000	3000	3000	3000	3000
	80	196	196	389	389
	4,9 L	15 L	15 L	25 L	25 L
	1	2	2	2	2
	-	-	-	-	1
	✓	✓	✓	✓	✓
CC	12V - 8,3A	12V - 8,3A	12V - 8,3A	12V - 8,3A	12V - 8,3A
	✓	✓	✓	✓	✓
Disyuntor Disjoncteur Circuit breaker	✓	✓	✓	✓	✓
	455x385x356	617x462x465	717x465x465	805x540x580	805x540x580
Peso Poids Peso (Kg)	24,2	46,2	54,5	99,7	99,7
Código Code Código	9130S	202035S	201203S	201205S	201237S

AVR: Regulación automática del Voltaje (Tensión)

AVR: Régulation automatique de Voltage (Tension)

AVR: Regulação automática de tensão



# GRUPOS ELECTRÓGENOS

## GROUPES ÉLECTROGÈNES

### GRUPOS GERADORES DE ENERGIA

**CT3500A**



**CT6500A**



**CT8000A**



**CT8000A-3**



	CT3500A	CT6500A	CT8000A		CT8000A-3
Tipo Type Serie	4T	4T	4T	4T	4T
	Monofásic Monophase Monofásica 50Hz-230V				Trifásico Triphasé Trifásica 50Hz-400V
KVA	2,8	5	6	6	7,5
MAX KVA	3,1	5,5	6,5	6,5	9
Cos $\varphi$	1	1	1	1	0,8
	15 h	9 h	8 h	8 h	8 h
<b>AVR</b>	✓	✓	✓	✓	✓
	✓	✓	✓	✓	✓
	✓	✓	✓	✓	✓
LWA	96 dB(A)	97 dB(A)	97 dB(A)	97 dB(A)	97 dB(A)
Motor Moteur Motor	G210FA	G390F	G420F-1	G420FD-1	G420FD-1
	Manual Manuel Manual			Eléctrico Électrique Elétrico	
	-	-	-	✓	✓
KW	4,4	8,2	9	9	9
	3000	3000	3000	3000	3000
cm <sup>3</sup>	212	389	420	420	420
	15 L	25 L	25 L	25 L	25 L
	2	3	3	3	3
	✓	✓	✓	✓	✓
	12V - 8,3A	12V - 8,3A	12V - 8,3A	12V - 8,3A	12V - 8,3A
<b>ALERT OIL</b>	✓	✓	✓	✓	✓
Disyuntor Disjoncteur Circuit breaker	✓	✓	✓	✓	✓
	590x430x467		681x546x566		
Peso Poids Peso (Kg)	45	77	80	83	86
Código Code Código	<b>8970</b>	<b>8971</b>	<b>8973</b>	<b>8974</b>	<b>8983</b>

**AVR: Regulación automática del Voltaje (Tensión)**

AVR: Régulation automatique de Voltage (Tension)

AVR: Regulação automática de tensão

# GRUPOS ELECTRÓGENOS

## GROUPES ÉLECTROGÈNES

### GRUPOS GERADORES DE ENERGIA

**GP-2500M**



**GP-3500M**



**GP-4500M**



**GH-5000M**



	GP-2500M	GP-3000M	GP-3500M	GP-4000M	GP-4500M	GH-4900M	GH-5000M	GH-5000M AVR
Tipo Type Serie	4T	4T	4T	4T	4T	4T	4T	4T
	Monofásico Monophasé Monofásica 50Hz-230V							
	2,7	2,7	2,7	3,5	3,5	4,5	4,5	4,5
	3	3	3	3,8	3,8	5	5	5
Cos φ	0,8	0,8	0,8	0,8	0,8	0,8	0,8	0,8
	3,5 h	3,5 h	3,5 h	2,5 h	2,5 h	3,0 h	3,0 h	3,0 h
	-	-	-	-	-	-	-	-
	-	-	✓	-	✓	-	✓	✓
LWA	97 dB(A)			98 dB(A)		99 dB(A)		
Motor Moteur Motor	HONDA GP-160			HONDA GP-200		HONDA GX-270		
	Manual Manuel Manual							
	3,6	3,6	3,6	4,3	4,3	6,3	6,3	6,3
	3000	3000	3000	3000	3000	3000	3000	3000
	163	163	163	196	196	270	270	270
	3,1 L	3,1 L	3,1 L	3,1 L	3,1 L	5,3 L	5,3 L	5,3 L
	2	2	2	2	2	2	2	2
<b>ALERT OIL</b>	✓	✓	✓	✓	✓	✓	✓	✓
Disyuntor Disjoncteur Circuit breaker	✓	✓	✓	✓	✓	✓	✓	✓
	550x430x480	600x400x500	600x630x525	600x400x500	600x630x525	730x500x500	800x770x700	
<b>AVR</b>	-	-	-	-	-	-	-	✓
Peso Poids Peso (Kg)	29	35	36	37	38	64	66	67
Código Code Código	<b>9390C</b>	<b>7885C</b>	<b>7902C</b>	<b>7951C</b>	<b>7956C</b>	<b>7249C</b>	<b>7163C</b>	<b>8815C</b>

AVR: Regulación automática del Voltaje (Tensión)  
 AVR: Régulation automatique de Voltage (Tension)  
 AVR: Regulação automática de tensão

# GRUPOS ELECTRÓGENOS

## GROUPES ÉLECTROGÈNES

### GRUPOS GERADORES DE ENERGIA

#### GH-5000ME



#### GH-6500M



#### GH-6500ME



	GH-5000 ME	GH-5000ME AVR	GH-6000M	GH-6500M	GH-6500M AVR	GH-6500 ME	GH-6500ME AVR	GH2 10000M	GH2 10000M AVR	
Tipo Type Serie	4T	4T	4T	4T	4T	4T	4T	4T	4T	
	Monofásico Monophasé Monofásica 50Hz-230V									
	4,5	4,5	6,8	6,8	6,8	6,8	6,8	12	12	
	5	5	7,5	7,5	7,5	7,5	7,5	12,5	12,5	
cos φ	0,8	0,8	0,8	0,8	0,8	0,8	0,8	0,8	0,8	
	3,0 h	3,0 h	2,5 h	2,5 h	2,5 h	2,5 h	2,5 h	7 h	7 h	
	✓	✓	-	✓	✓	✓	✓	✓	✓	
LWA	99 dB(A)	99 dB(A)	99 dB(A)	99 dB(A)	99 dB(A)	99 dB(A)	99 dB(A)	99 dB(A)	99 dB(A)	
Motor Moteur Motor	HONDA GX-270		HONDA GX-390				HONDA GX-630			
	Eléctrico Électrique Elétrico		Manual Manuel Manual			Eléctrico Électique Elétrico				
	6,3	6,3	8,7	8,7	8,7	8,7	8,7	15,5	15,5	
	3000	3000	3000	3000	3000	3000	3000	3000	3000	
	270	270	389	389	389	389	389	688	688	
	5,3 L	5,3 L	6,1 L	6,1 L	6,1 L	6,1 L	6,1 L	25 L	25 L	
	2	2	2	2	2	2	2	1	1	
	-	-	-	-	-	-	-	1	1	
Disyuntor Disjoncteur Circuit breaker	✓	✓	✓	✓	✓	✓	✓	✓	✓	
	880x790x700		880x560x530		800x770x700		880x790x700		1140x720x700	
	-	✓	-	-	✓	-	✓	-	✓	
	✓	✓	✓	✓	✓	✓	✓	✓	✓	
Peso Poids Peso (Kg)	68	69	78	80	80	82	82	165	165	
Código Code Código	<b>7164C</b>	<b>8816C</b>	<b>7295C</b>	<b>4776C</b>	<b>8817C</b>	<b>4777C</b>	<b>8818C</b>	<b>8995C</b>	<b>8819C</b>	
<b>ACCESORIOS ACCESSOIRES ACESÓRIOS</b>										
45 Ah	<b>970003</b>	<b>970003</b>	-	-	-	<b>970003</b>	<b>970003</b>	✓	✓	
	<b>71544</b>	<b>GX-270</b>	Starter automático							
	<b>71545</b>	<b>GX-390</b>	Starter automático							
	<b>73458</b>	<b>GX-630</b>	Starter automático							
	<b>75013</b>		Arranque automático por señal externa, cierre de un contacto							
	<b>7967</b>		230 V Arranque por fallo de red con cuadro de conmutación de fases							

AVR: Regulación automática del Voltaje (Tensión)  
 AVR: Régulation automatique de Voltage (Tension)  
 AVR: Regulação automática de tensão

# GRUPOS ELECTRÓGENOS

## GROUPES ÉLECTROGÈNES

### GRUPOS GERADORES DE ENERGIA

**GH-7000T**



**GH-8000TE**



AVR: Regulación automática del Voltaje (Tensión)

AVR: Régulation automatique de Voltage (Tension)

AVR: Regulação automática de tensão

	GP-4000T	GH-7000T	GH-7000TE	GH-8000T	GH-8000TE	GH2 12000
Tipo Type Serie	4T	4T	4T	4T	4T	4T
	Trifásico/ Triphasé/ Trifásica 50Hz-400V					
KVA	3,2	5,5	5,5	7	7	12
MAX KVA	3,5	6	6	7,5	7,5	12,5
MONO KVA	2,6	3,5	3,5	3,5	4,5	6
cos φ	0,8	0,8	0,8	0,8	0,8	0,8
	3,5 h	3,5 h	3 h	2,5 h	2,5 h	7 h
	✓	✓	✓	✓	✓	✓
Motor Moteur Motor	HONDA GP-160	HONDA GX-270		HONDA GX-390		HONDA GX-630
	Manual Manuel Manual	Eléctrico Électrique Eléctrico		Manual Manuel Manual	Eléctrico Électrique Eléctrico	
KW	3,6	6,3	6,3	8,7	8,7	15,5
	3000	3000	3000	3000	3000	3000
	163	270	270	389	389	688
	3,1 L	5,3 L	5,3 L	6,1 L	6,1 L	25 L
	1	1	1	1	1	-
	-	-	-	-	-	1
	1	1	1	1	1	1
Disyuntor Disjoncteur Circuit breaker	✓ MONO	✓ MONO	✓ MONO	✓ MONO	✓ MONO	✓ MONO
	770x765x615	880x790x700	880x790x700	880x790x700	880x790x700	1140x720x700
LWA	97 dB(A)	99 dB(A)	99 dB(A)	99 dB(A)	99 dB(A)	99 dB(A)
<b>ALERT OIL</b>	✓	✓	✓	✓	✓	✓
Peso Poids Peso (Kg)	37	66	68	80	82	165
Código Code Código	<b>7980C</b>	<b>4779C</b>	<b>4780C</b>	<b>4781C</b>	<b>4782C</b>	<b>8996C</b>
+ <b>AVR</b>	-	<b>7270C</b>	<b>7271C</b>	<b>7272C</b>	<b>7273C</b>	<b>7274C</b>
<b>ACCESORIOS • ACCESSOIRES • ACESÓRIOS</b>						
45 Ah	-	-	<b>970003</b>	-	<b>970003</b>	✓
	<b>71544</b>	<b>GX-270</b>	Starter automático			
	<b>71545</b>	<b>GX-390</b>	Starter automático			
	<b>73458</b>	<b>GX-630</b>	Starter automático			
	<b>75013</b>		Arranque automático por señal externa, cierre de un contacto			
	<b>2849</b>		400V Arranque por falo de red con cuadro de conmutación de fases 10 KVA			
	<b>2858</b>		400 V Arranque por falo de red con cuadro de conmutación de fases 15 KVA			

# MOTOSOLDADORAS

## GROUPES DE SOUDAGE

### MOTOSOLDADORA

#### GSH-200M



#### GSH-200ME



#### ELECTRODOS • ELECTRODES • ELECTRODOS

**RUITILO:** El electrodo de empleo más normal y de un amplio abanico de utilizaciones.

**BÁSICO:** Electrodo técnico en alta seguridad. Para ciertas utilizaciones donde los requerimientos mecánicos son importantes.

**CELULÓSICO:** Electrodo adaptado para la soldadura descendente.

**RUTILE:** Electrode d'emploi courant et d'une grande souplesse d'utilisation.

**BASIQUE:** Electrode pour l'assemblage technique de haute sécurité. Cette utilisation est préconisée pour les pièces soumises à des contraintes mécaniques importants.

**CELULOLOSIQUE:** Electrode adaptée au soudage descendant.

**RUITILO:** Eles têm um revestimento contendo óxido de Ti. São os empregados mais comumente e pelas suas características oferecem um amplo leque de possibilidades.

**BÁSICO:** São eletrodos técnicos em alta segurança. São empregados para determinadas condições onde os requerimentos técnicos são importantes.



**CELULÓSICO:** Eles têm um revestimento feito de material orgânico (celulose). São os eletrodos para fazer soldadura descendente.

	GSH-200M	GSH-200ME	GSH-210MC	GSH-210MCE	GSH-200T	GSH-200TE
Tipo Type Serie	Corriente ALTERNA Courant ALTERNE Corrente ALTERNATA		Corriente CONTINUA Courant Continu Corrente CONTINUA			
	Monofásico/ Monophasé/ Monofásica 50Hz-230V				Trifásico/ Triphasé/ Trifásica 50Hz-400V	
	200	200	200	200	200	200
	160	160	170	170	170	170
	6,8	6,8	4,5	4,5	3,5	3,5
	-	-	-	-	6	6
	3,25	3,25	4,5	4,5	4,5	4,5
Tipo electrodo Type electrode Tipo electrodo	RUITILO RUTILE RUITILO		RUITILO - BASICOS - CELULOSICOS RUTILE - BASIQUE - CELLULOSIQUE RUITILO - BASICOS - CELULOSICOS			
	2,5 h	2,5 h	2,5 h	2,5 h	2,5 h	2,5 h
	✓	✓	✓	✓	✓	✓
Motor Moteur Motor	HONDA GX-390					HONDA GX-630
	Manual Manuel Manual	Eléctrico Électrique Elétrico	Manual Manuel Manual	Eléctrico Électrique Elétrico	Manual Manuel Manual	Eléctrico Électrique Elétrico
	8,7	8,7	8,7	8,7	8,7	8,7
	3000	3000	3000	3000	3000	3000
	389	389	389	389	389	389
	6,1 L	6,1 L	6,1 L	6,1 L	6,1 L	6,1 L
	2	2	2	2	1	1
	-	-	-	-	1	1
	✓	✓	✓	✓	✓	✓
Disyuntor Disjoncteur Circuit breaker	✓	✓	✓	✓	✓ MONO	✓ MONO
	880x790x700		880x790x700		880x790x700	
	99 dB(A)	99 dB(A)	99 dB(A)	99 dB(A)	99 dB(A)	99 dB(A)
Tipo Type Serie	4T	4T	4T	4T	4T	4T
<b>ALERT OIL</b>	✓	✓	✓	✓	✓	✓
Peso Poids Peso (Kg)	85	87	90	92	95	97
	4m + 2m	4m + 2m	4m + 2m	4m + 2m	4m + 2m	4m + 2m
Código Code Código	<b>4861C</b>	<b>4862C</b>	<b>4863C</b>	<b>4864C</b>	<b>4917C</b>	<b>4918C</b>
<b>ACCESORIOS • ACCESSOIRES • ACESÓRIOS</b>						
	45 Ah	-	970003	-	970003	970003

# ALTERNADORES CON TOMA DE FUERZA PARA TRACTOR

## ALTERNATEURS AVEC PRISE DE FORCE TRACTEUR

### ALTERNADORES COM TRATOR PTO

	ECOTRAC-16	ECOTRAC-22	ECOTRAC-24	ECOTRAC-33	ECOTRAC-33R	ECOTRAC-42R	ECOTRAC-50R
Marca <b>Marque</b> Marca	NSM	NSM	NSM	NSM	SINCRO	SINCRO	SINCRO
	Trifásico/ Triphasé/ Trifásica 50Hz-400V						
<b>CUADRO</b>	<b>X</b>	<b>X</b>	<b>Y</b>	<b>Y</b>	<b>V</b>	<b>V</b>	<b>Z</b>
<b>RPM</b>	3000	3000	1500	1500	1500	1500	1500
<b>KVA</b> CONTINUO TRI 400V/50HZ/f=0,8	16	20	25	30	30	45	50
<b>KVA</b> CONTINUO MONO 230V/50HZ/f=1	8	10	10	12	12	18	20
<b>HP<sup>(1)</sup></b>	33	40	50	60	92	124	144
Regulación alternador <b>Régulation de l'alternateur</b> Regulação do alternador	COMPOUND	COMPOUND	COMPOUND	COMPOUND	AVR	AVR	AVR
	746x583x958	958x645x1003	1110x727x1322	1135x640x915	1135x640x915	1135x640x915	1135x640x915
Peso <b>Poids</b> Peso (Kg)	121	148	193	205	228	258	298
Código <b>Code</b> Código	<b>8645</b>	<b>8646</b>	<b>8611</b>	<b>8612</b>	<b>8612R</b>	<b>8613R</b>	<b>8614R</b>

<b>X</b>	Interruptor magnetotérmico diferencial 3P+N, 1 Toma monofásica CEE (2P+T) 32 A, 1 Toma Trifásica CEE (3P+N+T) 32 A y frecuencímetro a 5 leds (IP44).	Interrupteur magnétothermique différentiel 3P+N, 1 Prise monophasée CEE(2P+T) 32 A, 1 Prise triphasée CEE (3P+N+T) 32 A et compteur de fréquence a 5 leds (IP44).	Interruptor magnetotérmico diferencial 3P+N, 1 Tomada monofásica CEE (2P+T) 32A, 1 Tomada Trifásica CEE (3P+N+T) 32A e frequencímetro a 5 Leds (IP44).
<b>Y</b>	Interruptor magnetotérmico diferencial 3P+N, 1 Toma monofásica CEE (2P+T) 32 A, 1 Toma Trifásica CEE (3P+N+T) 63 A y voltímetro-frecuencímetro a leds (IP44).	Interrupteur magnétothermique différentiel 3P+N, 1 Prise monophasée CEE(2P+T) 32 A, 1 Prise triphasée CEE (3P+N+T) 63 A e voltímetro-compteur de fréquence a leds (IP44).	Interruptor magnetotérmico diferencial 3P+N, 1 Tomada monofásica CEE (2P+T) 32A, 1 Tomada Trifásica CEE (3P+N+T) 63A e voltímetro-frequencímetro a Leds (IP44).
<b>V</b>	Interruptor magnetotérmico diferencial 3P+N, Interruptor magnetotérmico 2P, 1 Toma monofásica CEE (2P+T) 32 A, 1 Toma Trifásica CEE (3P+N+T) 63 A, voltímetro-frecuencímetro-amperímetro, toma Shuko con protector térmico y cuentahoras (IP44).	Interrupteur magnétothermique différentiel 3P+N, 1 Interrupteur magnétothermique 2P, 1Prise monophasée CEE(2P+T) 32 A, 1 Prise triphasée CEE (3P+N+T) 63 A, voltímetro- ampèremètre- compteur de fréquence, prise Shuko avec protecteur thermique et compteur d'heures (IP44).	Interruptor magnetotérmico diferencial 3P+N, Interruptor magnetotérmico 2P, 1 Tomada monofásica CEE (2P+T) 32A, 1 Tomada Trifásica CEE (3P+N+T) 63A, voltímetro-frequencímetro-amperímetro, tomada Shuko con protetor térmico e conta horas (IP44).
<b>Z</b>	Interruptor magnetotérmico diferencial 3P+N, Interruptor magnetotérmico 2P, 1 Toma monofásica CEE (2P+T) 32 A, 1 Toma Trifásica CEE (3P+N+T) - 125 A, voltímetro-frecuencímetro-amperímetro, toma Shuko con protector térmico y cuentahoras (IP44).	Interrupteur magnétothermique différentiel 3P+N, 1 Interrupteur magnétothermique 2P, 1Prise monophasée CEE(2P+T) 32 A, 1 Prise triphasée CEE (3P+N+T) 125 A, voltímetro- ampèremètre- compteur de fréquence, prise Shuko avec protecteur thermique et compteur d'heures (IP44).	Interruptor magnetotérmico diferencial 3P+N, Interruptor magnetotérmico 2P, 1 Tomada monofásica CEE (2P+T) 32A, 1 Tomada Trifásica CEE (3P+N+T) 125A, voltímetro-frequencímetro-amperímetro, tomada Shuko con protetor térmico e conta horas (IP44).

#### ECOTRAC-24



**ALTERNADOR: IP23, auto-excitado, autoregulado y auto-ventilado, se suministra conjuntamente con un multiplicador con engranajes en baño de aceite y toma de fuerza para tractor (370-430 rpm) (Cardan no incluido), cuadro eléctrico y chasis de sujeción al tractor mediante los clásicos 3 puntos.**

**ALTERNATEUR: IP23, auto-excité, auto-régulé et auto-ventilé, est fourni avec un multiplicateur à engrenages à bain d'huile et prise de force tracteur (370-430 rpm) (Cardan non inclus), panneau électrique et la fixation au châssis du tracteur par les trois points classiques.**

**ALTERNADOR: IP23, auto-excitado, autorregulado e auto-ventilado é fornecido conjuntamente com um multiplicador com engrenagens em banho de óleo e tomada de força para trator (370-430 rpm) (Cardan não incluído), quadro elétrico e chassi de fixação ao trator usando os clássicos 3 pontos.**

**ATENCIÓN: El alternador ECOTRAC con AVR no es compatible con cuadros con variadores de frecuencia. Consulte su caso con nuestro departamento técnico. Los alternadores ECOTRAC se entregan sin aceite en el multiplicador.**

**AVERTISSEMENT: L'alternateur ECOTRAC avec AVR ne supporte pas les tableaux avec variateurs de fréquence. Consultez notre département technique sur votre cause. Les alternateurs ECOTRAC sont livrés sans huile dans le multiplicateur.**

**ATENÇÃO: O Alternador com AVR não é compatível com quadros com variadores de frequência. Consulte o seu caso com o nosso departamento técnico. Os Alternadores ECOTRAC são fornecidos sem óleo no multiplicador**

**(1) Potencia aconsejada para el tractor, valor sólo orientativo.**

**(1) Puissance recommandée pou le tracteur, valeur indicative veulement.**

**(1) Potencia recomendada para o trator, apenas valor indicativo.**

# RECOMENDACIONES PARA LA ELECCION DE UN GENERADOR

## A. POTENCIA

Hay dos tipos de aparatos que podemos conectar a un generador, los puramente resistivos (equipos de resistencia) y los equipos accionados por un motor eléctrico (equipos de inducción)

- **Equipos de inducción:** Son aquellos accionados por un motor eléctrico (bombas eléctricas, compresores, taladros, fresadoras, sierras, etc.) y que normalmente requieren una potencia de arranque de 2 a 4 veces mayor que su potencia nominal. Para calcular la potencia necesaria debemos multiplicar la potencia nominal del dispositivo por su coeficiente de arranque. Consultar la tabla que hay a continuación para el cálculo de las necesidades. Una vez tengamos el cálculo de cada equipo que vamos a conectar al generador, debemos sumarlos todos para obtener el valor total de los requisitos de potencia. Para alargar la vida útil del grupo electrógeno recomendamos aumentar este valor en al menos un 20% para mayor seguridad.
- **Equipos de resistencia:** Son aparatos que consumen potencia activa (lámparas incandescentes, calefacción eléctrica, placa de cocina...) y no representan ningún problema para los grupos electrógenos, ya que transforman íntegramente la potencia absorbida en luz o calor, por lo tanto, el factor multiplicador es siempre 1. Por ejemplo: un calentador de agua eléctrico de 2000 W, al arranque absorbe la misma potencia, 2000 W.

Basándonos en la tabla siguiente debemos multiplicar el coeficiente por la potencia nominal del equipo y sumar todos los valores para obtener el valor de la potencia mínima que debe tener el generador. Sobre el valor obtenido es recomendable darle un margen de seguridad para no hacer trabajar al generador al 100% y garantizar una vida útil más prolongada de su generador (como se ha indicado antes al menos un +20%)

EQUIPO	Coefficiente multiplicador potencia nominal
Luz incandescente, halógenas o led, Calefactor, Calentador, Cafetera, Ordenador, Impresoras, Fotocopiadora, Horno eléctrico (no microondas), Placas eléctricas	1
Radiadores, cargador batería, Caldera de gas/leña, Pistola de aire caliente, freidora	1,2
Bombas de superficie, Ventilador, Luces de neón, Taladro, Sierra circular, Aspirador, Horno microondas, tronzadora, Cizalla, Lijadora, Aguja vibratoria, Mezcladora, Corta setos	2
Amoladora, Bomba sumergida trifásica,	2,5
Congelador, Nevera, Compresor, Secadora de ropa, Montacargas, Hormigonera, Bomba sumergible, Motor puerta garaje	3
Perforador, Ordeñadora, Bomba de calor, Aire acondicionado	3,5
Sierra para madera, Hidro limpiadora, Lavadora	4
<b>Todos estos coeficientes deben considerarse orientativos (ver además tabla Como escoger un grupo electrógeno en INFORMACION TECNICA)</b>	

## También hay que tener en cuenta la diferencia entre la potencia nominal y máxima de un generador

- **La potencia nominal** se refiere a la potencia que el grupo puede trabajar en continuo. El número de horas dependerá de si el generador es de 1500 rpm o de 3000 rpm.
- **La potencia máxima** se refiere a la carga máxima que puede soportar el generador, teniendo en cuenta que su uso continuado no puede sobrepasar los 20 minutos.

## B. TIPO

Necesitamos saber para que se utilizará el generador, fundamentalmente hay dos tipos de generadores, los que son inverter y los que no lo son.

Los generadores inverter tienen varias particularidades: acostumbran a ser más pequeños que sus homólogos que no lo son, y suministran una corriente más estable, sin picos de tensión ni alteraciones en el suministro (similar a la suministrada por las compañías eléctricas) peso y tamaño se reducen a la mitad respecto un generador convencional, también 10/15dB menos y entre un 20% y un 40% menor consumo, se recomiendan para poder alimentar aparatos sensibles como televisores, ordenadores, móviles, etc.

Los aparatos eléctricos más simples no necesitan ningún sistema de regulación de voltaje, pero para aparatos más sensibles y sobre todo los que están controlados electrónicamente si será necesario un sistema inverter o que el alternador tenga AVR (Regulador automático de Voltaje).

El AVR se basa en un dispositivo que se haya dentro del alternador y que regula el voltaje del mismo para hacerlo más estable.

## C. LUGAR

Es importante el lugar donde va a estar instalado el generador, si el ruido generado por el mismo no es ningún problema, podemos optar por un generador ABIERTO, en caso contrario nuestra mejor opción sería un generador INSONORIZADO.

Si el generador lo vamos a instalar dentro de una caseta, hay que asegurarse que el mismo este lo suficientemente aireado con entradas y salidas de aire desde el exterior (se recomienda la instalación de un extractor que garantice una renovación suficiente de aire) y que el tubo de escape tenga una salida de humos directamente al exterior; dicha tubería deber ser del diámetro suficiente para no provocar sobrepresiones, se recomienda que como mínimo sea el doble de la salida de escape del motor.

## D. MOTORIZACIÓN Y REGIMEN

Si el generador va a utilizarse por largos períodos de tiempo, nuestra recomendación sería la de un motor Diesel a 1500rpm, si por el contrario el uso va a ser puntual o esporádico, es mejor optar por un generador a gasolina a 3000 rpm.

(En el caso de 3000 rpm no se deberían superar las 3h diarias de funcionamiento)

## E. OTRAS CONSIDERACIONES

Para la elección final del generador debemos tener en cuenta otras consideraciones:

- Tipo de arranque: Los generadores pueden ser de arranque manual o eléctrico, dependiendo del uso que queramos darle al mismo optaremos por una de estas dos opciones.
- Movilidad del grupo: Dependiendo de si el generador va a estar en una ubicación fija o móvil, optaremos por un generador con este accesorio o no.
- Cuadro ATS o fallo de red: Si la utilización del generador va a ser para la alimentación por fallo de red, optaremos por un generador con esta opción.
- Arranque remoto por señal externa: En caso de que queramos arrancar el generador de forma automática debido a alguna condición, será necesaria esta opción.

# RECOMMANDATIONS POUR LE CHOIX D'UN GÉNÉRATEUR

## A. PUISSANCE

Il existe deux types d'appareils que l'on peut connecter à un générateur, les purement résistifs (équipement à résistance) et les équipements entraînés par un moteur électrique (équipement à induction)

- **Appareils à induction** : Ce sont ceux alimentés par un moteur électrique (électropompes, compresseurs, perceuses, fraiseuses, scies, etc.) et qui nécessitent normalement une puissance de démarrage 2 à 4 fois supérieure à leur puissance nominale. Pour calculer la puissance nécessaire il faut multiplier la puissance nominale de l'appareil par son coefficient de démarrage. Consultez le tableau ci-dessous pour calculer les besoins. Une fois que nous avons le calcul de chaque équipement que nous allons connecter au générateur, nous devons tous les additionner pour obtenir la valeur totale des besoins en puissance. Pour prolonger la durée de vie du générateur, nous recommandons d'augmenter cette valeur d'au moins 20 % pour plus de sécurité.
- **Appareils à résistance** : Ce sont des appareils qui consomment de la puissance active (lampes à incandescence, chauffage électrique, table de cuisson ...) et ne représentent aucun problème pour les générateurs, car ils transforment complètement la puissance absorbée en lumière ou en chaleur, par conséquent, le facteur multiplicateur est toujours 1. Par exemple : un chauffe-eau électrique de 2000 W absorbe la même puissance au démarrage, 2000 W.

Sur la base du tableau suivant, il faut multiplier le coefficient par la puissance nominale de l'équipement et additionner toutes les valeurs pour obtenir la valeur de la puissance minimale que doit avoir le générateur. Sur la valeur obtenue, il convient de donner une marge de sécurité afin de ne pas faire fonctionner le générateur à 100% et de garantir une durée de vie plus longue de votre générateur (comme indiqué précédemment au moins + 20%)

EQUIPEMENT	Coefficient multiplicateur de puissance nominale
Lampe à incandescence, halogène ou led, Chauffage, Cafetière, Ordinateur, Imprimantes, Copieur, Four électrique (pas de micro-ondes), Plaques de cuisson électriques	1
Radiateurs, chargeur de batterie, Chaudière gaz/bois, Pistolet à air chaud, friteuse	1,2
Pompes de surface, Ventilateur, Néons, Perceuse, Scie circulaire, Aspirateur, Four à micro-ondes, Scie à onglet, Cisaille, Ponceuse, Aiguille vibrante, Mélangeur, Taille-haie	2
Meuleuse, Pompe submersible triphasique	2,5
Congélateur, Réfrigérateur, Compresseur, Sèche-linge, Chariot élévateur, Bétonnière, Pompe submersible, Moteur de porte de garage	3
Perforateur, Machine à traire, Pompe à chaleur, Climatiseur	3,5
Scie à bois, Hydro nettoyeur, Machine à laver	4
<b>Tous ces coefficients doivent être considérés comme un guide (voir aussi le tableau « Comment choisir un groupe électrogène pour entraîner un moteur électrique » dans les dernières pages du catalogue (INFORMATIONS TECHNIQUES))</b>	

La différence entre la puissance nominale et la puissance maximale d'un générateur doit également être prise en compte.

- La **puissance nominale** fait référence à la puissance que le générateur peut travailler en continu. Le nombre d'heures dépendra si le générateur est à 1500 tr/min ou 3000 tr/min.
- La **puissance maximale** fait référence à la charge maximale que le générateur peut supporter, en tenant compte du fait que son utilisation continue ne peut excéder 20 minutes.

## B. TYPE

Nous devons savoir à quoi servira le générateur, il existe essentiellement deux types de générateurs, ceux qui sont des inverter et ceux qui ne le sont pas.

Les générateurs inverter ont plusieurs particularités : ils ont tendance à être plus petits que leurs homologues qui ne le sont pas, et ils fournissent un courant plus stable, sans pics de tension ni perturbations d'alimentation (similaire à celui fourni par les compagnies d'électricité) poids et encombrement sont réduits de moitié par rapport à un générateur classique également 10/15dB en moins et entre 20% et 40% de consommation en moins, ils sont recommandés pour pouvoir alimenter des appareils sensibles tels que télévisions, ordinateurs, téléphones portables, etc.

Les appareils électriques les plus simples n'ont besoin d'aucun système de régulation de tension, mais pour les appareils plus sensibles et surtout ceux qui sont contrôlés électroniquement, un système inverter sera nécessaire ou que l'alternateur possède un AVR (Automatic Voltage Regulator).

L'AVR est basé sur un dispositif à l'intérieur de l'alternateur qui régule sa tension pour le rendre plus stable.

## C. LIEU

L'endroit où le générateur sera installé est important, si le bruit généré par celui-ci n'est pas un problème, nous pouvons opter pour un générateur OUVERT, sinon notre meilleure option serait un générateur INSONORISÉ.

Si le générateur doit être installé à l'intérieur d'une maison, il faut s'assurer qu'il est suffisamment aéré avec des entrées et sorties d'air de l'extérieur (l'installation d'un extracteur est recommandée pour garantir un renouvellement d'air suffisant) et que le tuyau d'échappement a une sortie de fumée directement à l'extérieur; le dit tuyau doit être d'un diamètre suffisant pour ne pas provoquer de suppressions, il est recommandé qu'il soit au moins le double de la sortie d'échappement du moteur.

## D. MOTORISATION ET RÉGIME

Si le générateur doit être utilisé pendant de longues périodes, notre recommandation serait un moteur diesel à 1500 tr/min, si au contraire l'utilisation doit être occasionnelle ou sporadique, il vaut mieux opter pour un générateur à essence à 3000 tr/min.

(Dans le cas de 3000 tr/min, il ne doit pas dépasser 3 heures par jour de fonctionnement)

## E. AUTRES CONSIDÉRATIONS

Pour le choix final du générateur, nous devons prendre en compte d'autres considérations :

- Type de démarrage : Les générateurs peuvent être à démarrage manuel ou électrique. En fonction de l'usage que l'on veut lui donner, on choisira l'une de ces deux options.
- Mobilité de générateur : Selon que le générateur va être en emplacement fixe ou mobile, nous choisirons un générateur avec cet accessoire ou non.
- Panne ATS ou panne de réseau : Si l'utilisation du générateur doit être pour l'alimentation électrique en raison d'une panne de courant, nous choisirons un générateur avec cette option.
- Démarrage à distance par signal externe : Dans le cas où nous souhaitons démarrer le générateur automatiquement en raison d'une condition, cette option sera nécessaire.



# RECOMENDAÇÕES PARA A ESCOLHA DE UM GERADOR

## A. POTÊNCIA

Existem dois tipos de dispositivos que podemos conectar a um gerador, os puramente resistivos (equipamentos de resistência) e os equipamentos acionados por um motor elétrico (equipamentos de indução).

- Equipamentos de indução: São aqueles acionados por motor elétrico (bombas elétricas, compressores, furadores, fresadoras, serras, etc.) e que normalmente requerem uma potência de partida de 2 a 4 vezes maior que sua potência nominal. Para calcular a potência necessária, devemos multiplicar a potência nominal do dispositivo pelo seu coeficiente inicial. Consulte a tabela abaixo para calcular as necessidades. Uma vez que tenhamos o cálculo de cada equipamento que vamos conectar ao gerador, devemos somar todos eles para obter o valor total das necessidades de energia. Para prolongar a vida útil do grupo gerador, recomendamos aumentar este valor em pelo menos 20% para maior segurança.
- Equipamentos de resistência: São dispositivos que consomem energia ativa (lâmpadas incandescentes, aquecimento elétrico, placas de cozinha...) e não representam nenhum problema para os geradores, pois transformam completamente a energia absorvida em luz ou calor, portanto, o fator multiplicador é sempre 1. Por exemplo: um esquentador elétrico de 2000 W absorve a mesma potência no arranque, 2000 W.

Com base na tabela a seguir, devemos multiplicar o coeficiente pela potência nominal do equipamento e somar todos os valores para obter o valor da potência mínima que o gerador deve ter. Sobre o valor obtido, é aconselhável dar uma margem de segurança para não fazer o gerador funcionar a 100% e garantir uma vida útil mais longa do seu gerador (conforme indicado anteriormente pelo menos + 20%)

EQUIPAMENTO	Coefficiente multiplicador potência nominal
Luz incandescente, halógena ou led, Aquecedor, Aquecedor, Máquinas de café, Computador, Impressoras, Copiadora, Forno elétrico (não micro-ondas), Placas elétricas -	1
Radiadores, Carregador de bateria, Caldeira a gás/lenha, Pistola de ar quente, fritadeira	1,2
Bombas de superfície, ventilador, luzes de néon, furadeira, serra circular, aspirador de pó, forno de micro-ondas, serra de esquadria, tesoura, lixadeira, agulha vibratória, misturador, corta sebes	2
Rebarbadora, Bomba submersa trifásica	2,5
Congelador, Refrigerador, Compressor, Secadora de roupa, Empilhador, Betoneira, Bomba submersível, Motor de porta de garagem	3
Perfurador, máquina de ordenha, bomba de calor, ar condicionado	3,5
Serra de madeira, hidro limpador, Máquina de lavar	4
<b>Todos estes coeficientes devem ser considerados como um guia (veja também a tabela como escolher um gerador em INFORMAÇÃO TÉCNICA)</b>	

A diferença entre a potência nominal e máxima de um gerador também deve ser levada em consideração.

- **A potência nominal** refere-se à potência que o grupo pode trabalhar continuamente. O número de horas dependerá se o grupo é 1500 rpm ou 3000 rpm.
- **A potência máxima** refere-se à carga máxima que o grupo pode suportar, tendo em conta que a sua utilização contínua não pode ultrapassar 20 minutos.

## B. TIPO

Necessitamos saber para que vai servir o gerador, existem basicamente dois tipos de geradores, os que são inverter e os que não são.

Os geradores inverter têm várias peculiaridades: tendem a ser menores que os que não são e fornecem uma corrente mais estável, sem picos de tensão ou distúrbios de alimentação (semelhante ao fornecido pelas concessionárias de energia elétrica), reduzem pela metade em relação a um convencional gerador, também 10/15dB a menos e entre 20% e 40% menor consumo, são recomendados para poder alimentar dispositivos sensíveis como televisores, computadores, telefones celulares, etc.

Os aparelhos elétricos mais simples não precisam de nenhum sistema de regulação de tensão, mas para aparelhos mais sensíveis e principalmente os que são controlados eletronicamente, será necessário um sistema inverter ou que o alternador tenha AVR (Regulador Automático de Tensão).

O AVR é baseado em um dispositivo dentro do alternador que regula a sua tensão para torná-lo mais estável.

## C. LOCAL

O local onde o gerador será instalado é importante, se o ruído gerado por ele não for um problema, podemos optar por um gerador ABERTO, caso contrário a melhor opção será um gerador INSONORIZADO.

Se o gerador for instalado dentro de uma casa, deve-se garantir que seja suficientemente ventilado com entradas e saídas de ar do lado de fora (recomenda-se a instalação de um extrator para garantir uma renovação de ar suficiente) e que o tubo de escape tenha uma saída de fumo diretamente para o exterior; O referido tubo deve ter diâmetro suficiente para não causar sobrepensões, recomenda-se que seja pelo menos o dobro da saída de exaustão do motor.

## D. MOTORIZAÇÃO E REGIME

Se o gerador for usado por longos períodos de tempo, recomendamos um gerador com motor a diesel a 1500 rpm, se pelo contrário o uso for ocasional ou esporádico, é melhor optar por um gerador a gasolina a 3000 rpm.

(No caso de 3000 rpm, não deve exceder 3 horas por dia de funcionamento)

## E. OUTRAS CONSIDERAÇÕES

Para a escolha final do gerador devemos levar em consideração outras considerações:

- Tipo de arranque: Os geradores podem ser de arranque manual ou elétrico. Dependendo do uso que queremos dar, escolheremos uma destas duas opções.
- Mobilidade em grupo: Dependendo se o gerador vai estar em um local fixo ou móvel, escolheremos um gerador com este acessório ou não.
- Quadro ATS ou falha de rede: Se a utilização do gerador for para alimentação por falha de rede, escolheremos um gerador com esta opção.
- Arranque remoto por sinal externo: Caso queiramos iniciar o gerador automaticamente devido a alguma condição, esta opção será necessária.





## ACCESORIOS EN HIERRO

ACCESSOIRES EN FER  
ACESSÓRIOS DE FERRO

---

### ACCESORIOS EN HIERRO

- Las medidas de los tubos para la manguera son en milímetros.
- Las medidas de las roscas son en pulgadas gas.
- Todas las piezas se entregarán zincadas, excepto las de soldar que son en negro.
- Podemos suministrar todas las piezas galvanizadas.
- En los pedidos citar siempre el n.º de figura.
- **TAMBIEN EN ACERO INOXIDABLE AISI 304, VER PÁGINA 125**

---

### ACCESSOIRES EN FER

- Les mesures des tubes pour les tuyaux sont en millimètres.
- Les mesures des filets sont en pouces gaz.
- Toutes les pièces seront livrées zinguées, sauf celles à souder qui sont en noire.
- Nous pouvons fournir toutes les pièces en galvanisé.
- Sur les commandes mentionner toujours le n.º de dessin.
- **AUSSI NOUS POUVONS FOURNIR DE L'ACIER INOX AISI 304, VOIR PAGE 125**

---

### ACESSÓRIOS DE FERRO

- As medição dos tubos para as mangueiras estão em milímetros.
- As medidas das roscas estão em polegadas gás.
- Todas as peças são entregues galvanizadas, exceto aquelas que estão soldadas que são em preto.
- Nós podemos fornecer todas as peças galvanizadas.
- Ao encomendar sempre incluir o número da figura.
- **TAMBÉM PODEMOS FORNECER EM AÇO INOX AISI 304, VER PÁGINA 125**

# ACCESORIOS EN HIERRO

ACCESSOIRES EN FER  
ACESSÓRIOS DE FERRO

**Fig. 111-S**

**Hembra para soldar • Femelle à souder • Fêmea para soldar**



	S-3	S-5	S-7	S-10	S-12	S-15	S-20	S-25	S-30
A	(1)	56	77	95	119	144	207	246	308
B	72	92	111	131	153	182	233	291	360
C	33	51	52	60	63	69	100	109	130
D	43	43	55	55	55	55	100	100	175
E	57	60	81	81	81	81	138	138	208
F	122	136	160	160	160	160	278	278	—
Kg	0,36	0,54	0,94	1,14	1,35	1,83	5	6,5	14

• La hembra siempre lleva incluida la junta

• Le joint est compris avec la femelle • A fêmea leva sempre a junta incluída

(1) 37 - 42 - 47 - 52 - 61

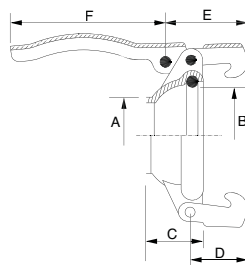

Tipo	∅ mm	Cod.
S-3	20	32179
	25	32180
	30	31652
	35	31653
	40	31654
	45	31655
	50	31656
S-5	60	31657
	60	31658
S-5	70	31659
	70	31660
S-7	75	31661
	80	31662
S-7	90	31663
	100	31664
S-10	110	31665
	120	31666
S-12	125	31667
	140	31668
	150	31669
S-15	160	31670
	200	31671
S-20	250	31672
S-30	300	31673

Tipo	S-3	S-5	S-7	S-10	S-12	S-15	S-20	S-25	S-30
∅ mm.	20-25-30-35-40-45-50-60	60-70	70-75-80-90	100-110	120-125	140-150-160	200	250	300

**Fig. 112-S**

**Macho parasoldar • Sphère à souder • Macho para soldar**

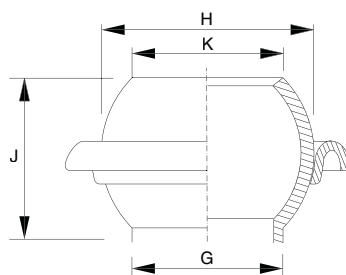

	S-3	S-5	S-7	S-10	S-12	S-15	S-20	S-25	S-30
G	(2)	56	75-89	95-114	119	144	205	244	305
H	70	90	110	130	150	180	242	300	368
J 53	73	83	90	102	104	137	170	210	210
K 51	63	83	100	120	145	194	252	210	305
Kg	0,23	0,42	0,66	0,9	1,3	2,15	5	8	14

• Los machos siempre incluyen el aro

• Le anneau est compris avec la sphère • Os machos sempre incluem o anel

(2) 34 - 43 - 49 - 61

Tipo	∅ mm	Cod.
S-3	1/2"	31674
	3/4"	31675
	1"	31676
	1 1/4"	31677
	1 1/2"	31678
	2"	31679
S-5	2"	31680
S-7	2 1/2"	31681
	3"	31682
S-10	3 1/2"	31683
	4"	31684
S-12	4 1/2"	31685
S-15	5"	31686
	6"	31687
S-20	8"	31688
S-25	10"	31689
S-30	12"	31690

Tipo	S-3	S-5	S-7	S-10	S-12	S-15	S-20	S-25	S-30
"Gas/Gaz	1/2"-3/4"-1"-1 1/4"-1 1/2"-2"	2"	2 1/2"-3"	3 1/2"-4"	4 1/2"	5"-6"	8"	10"	12"

# ACCESORIOS EN HIERRO

ACCESSOIRES EN FER  
ACESSÓRIOS DE FERRO

**Fig. 114-M**

**Hembra para manguera • Femelle porte-tuyau • Fêmea para mangueira**



Tipo	ø mm	Cod.
S-3	20	31691
	25	31692
	30	31693
	35	10802
	40	11530
	45	31694
	50	10809
S-5	60	10817
	50	31960
	60	31695
	70	13745
S-7	75	32446
	50	31961
	70	31696
	75	17268
	80	15122
	90	10976

Tipo	ø mm	Cod.
S-10	70	32185
	75	32432
	80	32010
	90	32011
	100	15123
	110	15124
S-12	120	32012
	110	32013
	120	31697
S-15	125	17327
	125	32014
	140	31698
	150	20092
S-20	160	31699
	200	090007
S-25	250	32015
S-30	300	31700
		31701

Tipo	S-3	S-5	S-7	S-10	S-12	S-15	S-20	S-25	S-30
ø mm.	20-25-30-35-40-45-50-60	60-70	70-75-80-90	100-110	120-125	140-150-160	200	250	300

**Fig. 115-R**

**Macho rosca exterior • Sphère filetage extérieur • Macho com rosca externa**



Tipo	GAS	Cod.
S-3	1/2"	31702
	3/4"	31703
	1"	10804
	1 1/4"	17168
	1 1/2"	10810
	2"	10819
S-5	2"	31704
	2 1/2"	32016
S-7	1 1/2"	17916
	2"	17917
	2 1/2"	15119
S-10	3"	10978
	2 1/2"	32307
	3"	32320
	3 1/2"	15120
	4"	15121

Tipo	GAS	Cod.
S-12	2 1/2"	32319
	3"	32306
	4"	32261
	4 1/2"	31705
S-15	5"	18930
	5"	31706
S-20	6"	18927
S-25	8"	31707
	10"	32017

Tipo	S-3	S-5	S-7	S-10	S-12	S-15	S-20	S-25
"Gas/Gaz	1/2"-3/4"-1"-1 1/4"-1 1/2"-2"	2"	2 1/2"-3"	3 1/2"-4"	4 1/2"	5"-6"	8"	10"

# ACCESORIOS EN HIERRO

ACCESSOIRES EN FER  
ACESSÓRIOS DE FERRO

**Fig. 116-RI**

**Macho rosca interior • Sphère filetage intérieur Macho com rosca interior**



Tipo	GAS	Cod.
S-3	1/2"	31708
	3/4"	31709
	1"	31710
	1 1/4"	18055
	1 1/2"	10814
	2"	11217
S-5	2"	13744
S-7	2 1/2"	31711
	3"	16254
S-10	3"	20214
	3 1/2"	31712
	4"	31713
S-12	3"	20215
	4 1/2"	32019
S-15	5"	31714
	6"	31715
S-20	8"	31716

Tipo	S-3	S-5	S-7	S-10	S-12	S-15	S-20
"Gas/Gaz	1/2"-3/4"-1"-1 1/4"-1 1/2"-2"	2"	2 1/2"-3"	3 1/2"-4"	4 1/2"	5"-6"	8"

**Fig. 118-R**

**Hembra con rosca • Femelle filetage extérieur • Fêmea com rosca**



Tipo	GAS	Cod.
S-3	1/2"	31717
	3/4"	31718
	1"	31719
	1 1/4"	31720
	1 1/2"	31721
	2"	15653
S-5	2"	31722
S-7	2 1/2"	31723
	3"	31724
S-10	3 1/2"	31725
	4"	31726
S-12	4 1/2"	31727
S-15	5"	31728
	6"	31729
S-20	8"	31730

Tipo	S-3	S-5	S-7	S-10	S-12	S-15	S-20
"Gas/Gaz	1/2"-3/4"-1"-1 1/4"-1 1/2"-2"	2"	2 1/2"-3"	3 1/2"-4"	4 1/2"	5"-6"	8"

# ACCESORIOS EN HIERRO

ACCESSOIRES EN FER  
ACESSÓRIOS DE FERRO

**Fig. 119-M**  
**Macho para manguera • Mâle porte-tuyau • Macho para mangueira**



Tipo	ø mm	Cod.
S-3	20	31731
	25	31732
	30	31733
	35	17248
	40	17249
	45	31734
	50	17250
S-5	60	17251
	50	32344
	60	31735
	70	17252
S-7	75	32445
	50	32352
	70	31736
	75	17267
S-10	80	17253
	90	17254
	70	32345
	80	32346
	90	32347
S-12	100	17255
	110	17256
	120	32348
S-15	100	32349
	120	31737
	125	17326
S-20	100	32350
	125	32351
	140	31738
	150	18926
S-25	160	31739
S-30	200	090006
S-25	250	31740
S-30	300	31741

Tipo	S-3	S-5	S-7	S-10	S-12	S-15	S-20	S-25	S-30
Ø mm.	20-25-30-35-40-45-50-60	60-70	70-75-80-90	100-110	120-125	140-150-160	200	250	300

# ACCESORIOS EN HIERRO

ACCESSOIRES EN FER  
ACESSÓRIOS DE FERRO

**Fig. 120-A**

**Aro • Anneau • Anel**



Tipo	∅ mm	Cod.
S-3	20	<b>92383</b>
	25	
	30	
	35	
	40	
	45	
S-5	50	<b>92384</b>
	60	
S-7	70	<b>92385</b>
	75	
	80	
	90	

Tipo	∅ mm	Cod.
S-10	100	<b>91870</b>
	110	
S-12	120	<b>92386</b>
	125	
S-15	140	<b>92387</b>
	150	
S-20	160	<b>92388</b>
S-25	200	
S-30	250	<b>31742</b>
	300	

	S-3	S-5	S-7	S-10	S-12	S-15	S-20	S-25	S-30
L	93	117	147	161	185	224	291	359	448
M	15	23	27	29	305	37	46	61	68
N	63	77	96	119	140	170	220	283	340

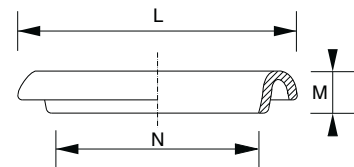

Tipo	S-3	S-5	S-7	S-10	S-12	S-15	S-20	S-25	S-30
∅ mm.	20-25-30-35-40-45-50-60	60-70	70-75-80-90	100-110	120-125	140-150-160	200	250	300

**Fig. 121-J**

**Junta • Joint • Junta**



Tipo	∅ mm	Cod.
S-3	20	<b>10803</b>
	25	
	30	
	35	
	40	
	45	
S-5	50	<b>13747</b>
	60	
S-7	70	<b>10977</b>
	75	
	80	
	90	

Tipo	∅ mm	Cod.
S-10	100	<b>9998</b>
	110	
S-12	120	<b>17915</b>
	125	
S-15	140	<b>30492</b>
	150	
S-20	160	<b>090814</b>
S-25	200	
S-30	250	<b>31744</b>
	300	

	S-3	S-5	S-7	S-10	S-12	S-15	S-20	S-25	S-30
P	80	104	125	144	168	202	273	320	400
Q	9	10	12	13	14	16	18	22	23
R	62	84	101	118	140	170	237	276	354

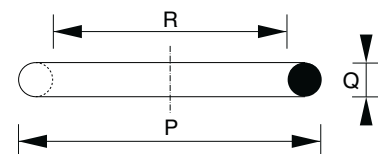

Tipo	S-3	S-5	S-7	S-10	S-12	S-15	S-20	S-25	S-30
∅ mm.	20-25-30-35-40-45-50-60	60-70	70-75-80-90	100-110	120-125	140-150-160	200	250	300



# ACCESORIOS EN HIERRO

ACCESSOIRES EN FER  
ACESSÓRIOS DE FERRO

**Fig. 125-M**

**Curvo hembra para manguera • Courbe avec femelle • Fêmea curva para mangueira**



Tipo	DN	Cod.
S-3	20	31757
	25	31758
	30	31759
	35	10807
	40	11531
	45	31760
	50	10812
S-5	60	10822
	65	32353
	70	31761

Tipo	DN	Cod.
S-7	70	13746
	75	31763
	80	15138
	90	10782
S-10	100	15139
	110	15140
S-12	120	31764
	125	18929
S-15	140	31765
	150	20164
	160	31766
S-20	200	092235
S-25	250	31767
S-30	300	31768

Tipo	S-3	S-5	S-7	S-10	S-12	S-15	S-20	S-25	S-30
Ø mm.	20-25-30-35-40-45-50-60	60-70	70-75-80-90	100-110	120-125	140-150-160	200	250	300

**Fig. 126-M**

**Curvo macho para manguera**

Courbe avec mâle

Macho curvo para mangueira



Tipo	DN	Cod.
S-3	20	31769
	25	31770
	30	31771
	35	31772
	40	31773
	45	31774
	50	31775
S-5	60	31776
	70	31777
S-7	70	31778
	75	31779
	80	31780
S-10	80	31781
	90	31782

Tipo	DN	Cod.
S-10	100	31783
	110	31784
S-12	120	31785
	125	31786
S-15	140	31787
	150	31788
	160	31789
S-20	200	31790
S-25	250	31791
S-30	300	31792

Tipo	S-3	S-5	S-7	S-10	S-12	S-15	S-20	S-25	S-30
Ø mm.	20-25-30-35-40-45-50-60	60-70	70-75-80-90	100-110	120-125	140-150-160	200	250	300

**Fig. 127-E-RT**

**Curvo hembra-macho**

Courbe mâle-femelle • Fêmea - macho curvo



Tipo	DN	Cod.
S-3	1/2"	31793
	3/4"	
	1"	
	1 1/4"	
	1 1/2"	
S-5	2"	31795
S-7	2 1/2"	31796
	3"	31797
S-10	3 1/2"	31798
	4"	31799

Tipo	DN	Cod.
S-12	4 1/2"	31800
S-15	5"	31801
	6"	31802
S-20	8"	31803
S-25	10"	31804
S-30	12"	31805

Tipo	S-3	S-5	S-7	S-10	S-12	S-15	S-20	S-25	S-30
"Gas/Gaz	1/2"-3/4"-1"-1 1/4"-1 1/2"-2"	2"	2 1/2"-3"	3 1/2"-4"	4 1/2"	5"-6"	8"	10"	12"

# ACCESORIOS EN HIERRO

ACCESSOIRES EN FER  
ACESSÓRIOS DE FERRO

**Fig. 152-T**

## Empalme forma T con tres conexiones

La junction forme T avec trois connexions Empalme em forma T com 3 ligações

M-M-M Ø 75 x 75 x 75 mm M-M-M Ø 100 x100 x100 mm



	Cod.
75 x 75 x75	<b>32228</b>
100 x 100 x100	<b>32209</b>

**Fig. 129-T**

## Tapón hembra • Bouchon à femelle • Tampão fêmea



Tipo	DN	Cod.
S-3	50	<b>31819</b>
S-5	60	<b>31820</b>
S-7	75	<b>31821</b>
S-10	100	<b>31822</b>
S-12	125	<b>31823</b>
S-15	150	<b>31824</b>
S-20	200	<b>31825</b>
S-25	250	<b>31826</b>
S-30	300	<b>31827</b>

Tipo	S-3	S-5	S-7	S-10	S-12	S-15	S-20	S-25	S-30
Ø mm.	20-25-30-35-40-45-50-60	60-70	70-75-80-90	100-110	120-125	140-150-160	200	250	300

**Fig. 130-T**

## Tapón macho • Bouchon mâle • Tampão macho



Tipo	Cod.
S-3	<b>31828</b>
S-5	<b>31829</b>
S-7	<b>31830</b>
S-10	<b>31831</b>
S-12	<b>31832</b>
S-15	<b>31833</b>
S-20	<b>31834</b>
S-25	<b>31835</b>
S-30	<b>31836</b>

Tipo	S-3	S-5	S-7	S-10	S-12	S-15	S-20	S-25	S-30
Ø mm.	20-25-30-35-40-45-50-60	60-70	70-75-80-90	100-110	120-125	140-150-160	200	250	300

**Fig. 131-B**

**Macho con brida • Mâle avec bride • Macho com abraçadeira**

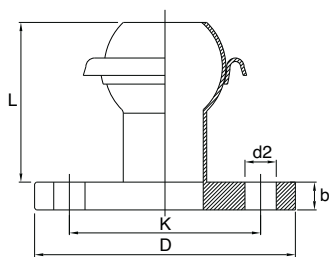

Tipo	DN	Cod.
S-3	40	<b>31837</b>
	50	<b>32354</b>
S-5	50	<b>31838</b>
S-7	65	<b>31839</b>
	80	<b>31840</b>
S-10	80	<b>32355</b>
	100	<b>31841</b>
S-12	100	<b>32356</b>
	125	<b>31842</b>
S-15	100	<b>32357</b>
	125	<b>32358</b>
	150	<b>31843</b>
S-20	200	<b>31844</b>
S-25	250	<b>31845</b>
S-30	300	<b>31846</b>

		DIN 2576		PN-10			
Tipo	DN	ØD	ØK	Ød2	b	Nº Taladros	L
S-3	40	150	110	18	16	4	90
S-5	50	165	125	18	18	4	120
S-7	65	185	145	18	18	4	160
S-7	80	200	160	18	20	4	160
S-10	100	220	180	18	20	8	180
S-12	125	250	210	18	22	8	200
S-15	150	285	240	22	22	8	200
S-20	200	340	295	22	24	8	240
S-25	250	395	350	22	26	12	270
S-30	300	445	400	22	26	12	330

**Fig. 242-J**

**Junta para brida • Joint pour bride • Junta para abraçadeira**



Tipo	DN	Cod.
1 1/2"	40	<b>31847</b>
2"	50	<b>31848</b>
2 1/2"	65	<b>31849</b>
3"	80	<b>31850</b>
4"	100	<b>31851</b>
5"	125	<b>31852</b>
6"	150	<b>31853</b>
8"	200	<b>31854</b>
10"	250	<b>31855</b>
12"	300	<b>31856</b>

		DIN 2576		PN-10							
Tipo	DN	1 1/2"	2"	2 1/2"	3"	4"	5"	6"	8" 1	0"	12"
		40	50	65	80	100	125	150	200	250	300

# ACCESORIOS EN HIERRO

ACCESSOIRES EN FER  
ACESSÓRIOS DE FERRO

**Fig. 132-ES**

## Macho con brida para grifo

Mâle avec bride pour robinet • Macho com abraçadeira para torneira



Tipo	Cod.
S-12	31870
S-15	31871

Tipo	S-12	S-15
------	------	------

**Fig. 134-RM**

## Reductor rosca-manguera •

Réduction filet-porte tuyau •

Redutor rosca-manguera



∅ mm	GAS	Cod.	∅ mm	GAS	Cod.
20	1/2"	31872	60	1 1/2"	32367
	3/4"	31873		1 1/4"	32368
	1"	31874		2"	31902 ref.10827
	1 1/4"	31875		2 1/2"	32369
	1 1/2"	31876		3"	32370
25	1/2"	31877	65	1 1/2"	32342
	3/4"	31878		2"	31903
	1"	31879	70	2"	32371
	1 1/4"	31880		2 1/2"	31904
	1 1/2"	31881		3"	32372
30	1/2"	31882	75	2"	32373
	3/4"	31883		2 1/2"	31905 ref.15117
	1"	31884	3"	32374	
	1 1/4"	31885	80	2 1/2"	32375
	1 1/2"	31886		3"	31906
35	1/2"	31887	90	2 1/2"	32376
	3/4"	31888		3"	31907 ref.10898
	1"	31889		3 1/2"	32377
	1 1/4"	31890		4"	32378
	1 1/2"	31891	100	3"	32321
1/2"	31892	3 1/2"		31908	
3/4"	31893	4"		31909	
40	1"	31894	110	3"	32379
	1 1/4"	31895 ref. 31963		3 1/2"	31910
	1 1/2"	31896		4"	31911 ref.15118
	2"	32360	4 1/2"	32380	
	1"	32361	120	4"	32381
1 1/2"	32362	4 1/2"		31912	
1 1/4"	32363	5"		32382	
45	2"	32364	130	4"	32383
	1/2"	31897		4 1/2"	31913
	3/4"	31898		5"	32384
	1"	31899	140	4 1/2"	32385
	1 1/4"	31900		5"	31914
1 1/2"	31901 ref. 10825	6"		32386	
2"	32365	150	5"	31915	
2 1/2"	32366		6"	32387	

∅ mm	GAS	Cod.
160	5"	32388
	6"	31916 ref.31966
200	6"	32389
	8"	31917

Otras posibilidades CONSULTAR

∅ mm	20 - 25 - 30 - 35 - 40 - 45 - 50 - 60 - 65 - 70 - 75 - 80 - 90 - 100 - 110 - 120 - 125 - 140 - 150 - 160 - 200 - 250 - 300													
"Gas/Gaz 1/2"	3/4"	1"	1 1/4"	1 1/2"	2"	2 1/2"	3"	3 1/2"	4"	4 1/2"	5"	6"	8"	

**Fig. 135-RR**

**Reductor rosca-rosca • Réduction filet-filet • Redutor rosca-rosca**



GAS	GAS	Cod.
1 1/4"	1"	<b>31922</b>
1 1/2"	1 1/4"	<b>31921</b>
2"	1"	<b>31923</b>
	1 1/4"	<b>31925</b>
2 1/2"	1 1/2"	<b>31924</b>
	1 1/4"	<b>31926</b>
3"	2"	<b>31927</b>
	2 1/2"	<b>31928</b>
3 1/2"	3"	<b>31929</b>
	2"	<b>31930</b>
4"	3"	<b>31931</b>
	3 1/2"	<b>32325</b>
	3 1/2"	<b>31932</b>
5"	4"	<b>31933</b>
6"	5"	<b>31934</b>
8"	6"	<b>31935</b>

Otras posibilidades CONSULTAR

"Gas/Gaz 1/2"	3/4"	1"	1 1/4"	1 1/2"	2"	2 1/2"	3"	3 1/2"	4"	4 1/2"	5"	6"	8"
---------------	------	----	--------	--------	----	--------	----	--------	----	--------	----	----	----

**Fig. 133-MM**

**Reductor manguera-manguera**

Réduction porte tuyau-porte tuyau • Redutor mangueira-mangueira



∅ mm	GAS	Cod.
20	25	<b>31936</b>
	30	<b>31937</b>
	35	<b>31938</b>
	40	<b>31939</b>
	45	<b>31940</b>
25	30	<b>31941</b>
	35	<b>31942</b>
	40	<b>31943</b>
	45	<b>31944</b>
30	35	<b>31945</b>
	40	<b>31946</b>
	45	<b>31947</b>
35	40	<b>31948</b>
	45	<b>31949</b>
	50	<b>32390</b>
40	45	<b>31950</b>
	50	<b>32391</b>
	60	<b>32392</b>
45	50	<b>32393</b>
	60	<b>32394</b>
50	60	<b>31951</b>
	70	<b>32395</b>
60	70	<b>32396</b>
	75	<b>32397</b>
65	70	<b>31952</b>
	75	<b>32398</b>

∅ mm	GAS	Cod.
70	75	<b>31953</b>
	80	<b>32399</b>
	90	<b>32400</b>
	100	<b>32401</b>
75	80	<b>32402</b>
	90	<b>32403</b>
	100	<b>32404</b>
80	90	<b>31954</b>
	100	<b>32405</b>
90	100	<b>32406</b>
	125	<b>32407</b>
	150	<b>32408</b>
100	110	<b>31955</b>
	125	<b>32409</b>
	150	<b>32410</b>
110	120	<b>32411</b>
	125	<b>32412</b>
120	125	<b>31956</b>
	140	<b>32413</b>
125	140	<b>32414</b>
	150	<b>32415</b>
140	150	<b>31957</b>
140	160	<b>31958</b>
	160	<b>31959</b>
150	200	<b>32416</b>

Diferentes posibilidades CONSULTAR

∅ mm	20 - 25 - 30 - 35 - 40 - 45 - 50 - 60 - 65 - 70 - 75 - 80 - 90 - 100 - 110 - 120 - 125 - 140 - 150 - 160 - 200 - 250 - 300
------	--

# ACCESORIOS EN HIERRO

ACCESSOIRES EN FER  
ACESSÓRIOS DE FERRO

**Fig. 137-RM**  
**Tubo rosca-manguera**

Tube filet porte-tuyau • Tubo rosca-mangueira

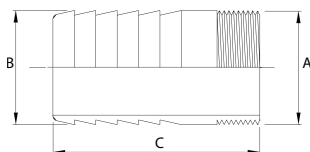

ø mm	GAS	Cod.
1/2"	20	<b>31962</b>
3/4"	26	<b>092030</b>
1"	33	<b>10823</b>
1 1/4"	42	<b>31963</b>
1 1/2"	48	<b>10825</b>
2"	60	<b>10827</b>
2 1/2"	75	<b>15117</b>
3"	89	<b>10898</b>
3 1/2"	100	<b>15105</b>
4"	112	<b>15118</b>
4 1/2"	125	<b>31964</b>
5"	140	<b>31965</b>
6"	163	<b>31966</b>

A	"Gas/"Gaz	1/2"	3/4"	1"	1 1/4"	1 1/2"	2"	2 1/2"	3"	3 1/2"	4"	4 1/2"	5"	6"
B	ø mm.	20	26	33	42	48	60	75	89	100	112	125	140	163
C	Long.	90	90	90	90	90	90	110	110	120	130	140	150	170

**Fig. 138-MM**

**Tubo manguera-manguera**

Tube porte tuyau-porte tuyau • Tubo mangueira-mangueira

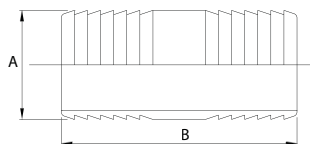

ø mm	Cod.
20	<b>31968</b>
25	<b>31969</b>
30	<b>31970</b>
35	<b>31971</b>
40	<b>31972</b>
45	<b>31973</b>
50	<b>31974</b>
60	<b>31975</b>
65	<b>31976</b>
70	<b>31977</b>
75	<b>31978</b>
80	<b>31979</b>
90	<b>31980</b>
100	<b>31981</b>
110	<b>31982</b>
120	<b>31983</b>
125	<b>31984</b>
140	<b>31985</b>
150	<b>31986</b>
160	<b>31987</b>
200	<b>31988</b>
250	<b>31989</b>
300	<b>31990</b>

A	ø mm	20	25	30	35	40	45	50	60	65	70	75	80	90	100	110	120	125	140	150	160	200	250	300
B	L.	120	120	120	120	120	120	120	120	130	140	180	180	180	200	200	230	240	250	250	260	400	500	500

**Fig. 139-C**  
Cono reductor • Réduction conique • Cone redutor



DN	Cod.
100/50	<b>31991</b>
125/55	<b>31993</b>
150/60	<b>32418</b>
150/100	<b>32419</b>
200/80	<b>32420</b>
200/100	<b>31997</b>

Ø mm.	100/50	125/50	100/80	125/80	150/80	200/100
-------	--------	--------	--------	--------	--------	---------

**Fig. 144-BR**  
Brida roscada • Bride fileté • Abraçadeira roscada

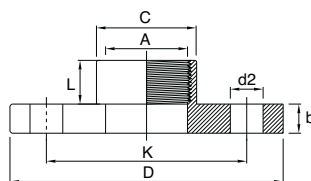

DN	GAS	Cod.
25	1"	<b>32186</b>
32	1 1/4"	<b>32020</b>
40	1 1/2"	<b>32021</b>
50	2"	<b>32022</b>
65	2 1/2"	<b>32023</b>
80	3"	<b>32024</b>
100	4"	<b>32025</b>
125	5"	<b>32026</b>
150	6"	<b>32027</b>
200	8"	<b>32028</b>

A "Gas/Gaz	DIN 2576			PN-10			Nº	C	L
	DN	ØD	ØK	Ød2	b				
1"	25	115	85	14	16	4	40	21	
1 1/4"	32	140	100	18	16	4	48	24	
1 1/2"	40	150	110	18	16	4	55	24	
2"	50	165	125	18	18	4	66	27	
2 1/2"	65	185	145	18	18	4	82	32	
3"	80	200	160	18	20	8	95	34	
4"	100	220	180	18	20	8	122	41	
5"	125	250	210	18	22	8	148	44	
6"	150	285	240	22	22	8	175	47	
8"	200	340	295	22	24	8	230	50	

**Fig. 145-BM**  
Brida con tubo para manguera  
Bride avec porte-tuyau • Abraçadeira com tubo para mangueira



DN	GAS	Cod.
25	30	<b>32425</b>
32	40	<b>32029</b>
40	50	<b>32030</b>
50	60	<b>32031</b>
65	75	<b>32032</b>
80	90	<b>32033</b>
100	100	<b>32034</b>
125	125	<b>32035</b>

DN	ØD	DIN 2576			PN-10			L
		d1	ØK	Ød2	b	Nº		
30	25	115	85	14	16	4	65	
40	32	140	100	18	16	4	65	
50	40	150	110	18	16	4	65	
60	50	165	125	18	18	4	70	
75	65	185	145	18	18	4	105	
90	80	200	160	18	20	8	110	
100	100	220	180	18	20	8	110	
125	125	250	210	18	22	8	130	

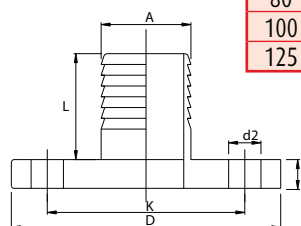

# ACCESORIOS EN HIERRO

ACCESSOIRES EN FER  
ACESSÓRIOS DE FERRO

**Fig. 146-BR**

**Brida con tubo roscado • Bride avec tube fileté • Abraçadeira com tubo roscado**



DN	ø	Cod.
25	1"	32421
32	1 1/4"	32040
40	1 1/2"	32041
50	2"	32042
65	2 1/2"	32043
80	3"	32044
100	4"	32045
125	5"	32046
150	6"	32047
200	8"	32048

DIN 2576		PN-10					
ØD	DN	ØD	ØK	ød2	b	Nº	L
1"	25	115	85	14	16	4	60
1 1/4"	32	140	100	18	16	4	60
1 1/2"	40	150	110	18	16	4	60
2"	50	165	125	18	18	4	65
2 1/2"	65	185	145	18	18	4	85
3"	80	200	160	18	20	8	90
4"	100	220	180	18	20	8	115
5"	125	250	210	18	22	8	120
6"	150	285	240	22	22	8	125
8"	200	340	295	22	24	8	80

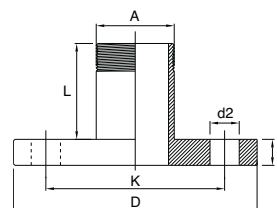

**Fig. 155-MM**

**Curva manguera-manguera**

Courbe porte-tuyau/porte-tuyau

Curva mangueira-mangueira



ø mm	Cod.
20	32049
25	32050
30	32051
35	32052
40	32053
45	32054
50	32055
60	32056
65	32057
70	32058
75	32059
80	32060
90	32061
100	32062
110	32063
120	32064
125	32065
140	32066
150	32067
200	32069
250	32070C
300	32071



**Fig. 148-R**

**Tubo con rosca para soldar**

Tube fileté à souder • Tubo com rosca para soldar

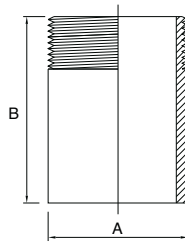

GAS	Cod.
1/2"	32072
3/4"	32073
1"	32074
1 1/4"	32075
1 1/2"	32076
2"	32077
2 1/2"	32078
3"	32079
3 1/2"	32080
4"	32081
4 1/2"	32082
5"	32083
6"	32084
8"	32085

A	"Gas/"Gaz	1/2"	3/4"	1"	1 1/4"	1 1/2"	2"	2 1/2"	3"	3 1/2"	4"	4 1/2"	5"	6"	8"
B	L	60	60	60	60	60	65	85	90	100	115	115	120	125	180

**Fig. 149-M**

**Tubo con regatas para soldar**

Tube porte-tuyau à souder • Tubo pegas para soldar

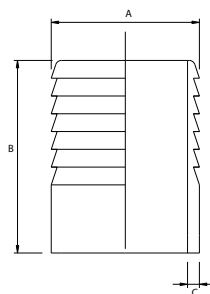

ø mm	Cod.	ø mm	Cod.
20	32086	90	32098
25	32087	100	32099
30	32088	110	32100
35	32089	120	32101
40	32090	125	32102
45	32091	140	32103
50	32092	150	32104
60	32093	160	32105
65	32094	200	32106
70	32095	250	32107
75	32096	300	32108
80	32097		

A	ø mm	20	25	30	35	40	45	50	60	65	70	75	80	90	100	110	120	125	140	150	160	200	250	300
B	L.	65	65	65	65	65	65	65	70	75	90	105	105	110	110	120	130	130	135	140	150	200	250	300
C		2	2	2	2	2	2	2	2	2	2	2	2	3	3	3	3	3	3	3	3	3	3	3

**Fig. 150-RI**

**Manguito rosca interior • Tube fileté intérieur • Tubo com rosca**



GAS	Cod.
1/2"	32109
3/4"	32110
1"	32111
1 1/4"	32112
1 1/2"	32113
2"	32114
2 1/2"	32115
3"	32116
4"	32117

"Gas/Gaz	1/2"	3/4"	1"	1 1/4"	1 1/2"	2"	2 1/2"	3"	3 1/2"	4"	4 1/2"	5"	6"	8"
----------	------	------	----	--------	--------	----	--------	----	--------	----	--------	----	----	----

# ACCESORIOS EN HIERRO

ACCESSOIRES EN FER  
ACESSÓRIOS DE FERRO

**Fig. 72**

## Válvula de retención hembra lat/inox

Clapet de rétention femelle laiton/inox • Válvula de retenção fêmea latão/Inox



G	Código Code Código	u. x bolsa Pcs x.enveloppe u. x saco
1" (26x34)	<b>31533</b>	10
1"1/4 (33x42)	<b>32192</b>	5
1"1/2 (40x49)	<b>32193</b>	5
2" (50x60)	<b>32194</b>	5
3" (75)	<b>32465</b>	5

**Fig. 156-V**

## Válvula de pie hierro fundido

Valve de pied fer fondu • Válvula com pé em ferro fundido



ø mm	Cod.
50	<b>25102</b>
60	<b>10124</b>
70	<b>25103</b>
80	<b>15440</b>
90	<b>25104</b>
100	<b>27497</b>
110	<b>15441</b>
125	<b>17513</b>

ø mm	50	60	70	80	90	100	110	125
------	----	----	----	----	----	-----	-----	-----

**Fig. 157-V**

## Válvula de pie galvanizada

Valve de pied galvanisée • Válvula com pé galvanizado



ø mm	Cod.
60	<b>18015</b>
80	<b>18016</b>
90	<b>18017</b>
100	<b>18018</b>
110	<b>18019</b>
125	<b>18021</b>
150	<b>18022</b>
200	<b>18023</b>
250	<b>18024</b>
300	<b>18025</b>
400	<b>18026</b>

ø mm	60	80	90	100	125	150	200	250	300	400
------	----	----	----	-----	-----	-----	-----	-----	-----	-----

**Fig. 158-F**

### Filtro para manguera galvanizado

Filtre pour tuyau galvanisé • Filtro para mangueira galvanizado



ø mm	Cod.
50	32155
60	32156
70	32157
75	32158
80	32159
90	32160
100	32161
110	32162
125	32163
150	32164
200	32165

**Fig. 147-BM**

### Brida con curva 90° para manguera

Bride avec courbe 90° et porte-tuyau • Abraçadeira com curva 90° para mangueira



DN	ØD	DIN 2576		PN-10		
		d1	ØK	Ød2	b	N°
30	25	115	85	14	16	4
40	32	140	100	18	16	4
50	40	150	110	18	16	4
60	50	165	125	18	18	4
75	65	185	145	18	18	4
90	80	200	160	18	20	8
100	100	220	180	18	20	8
125	125	250	210	18	22	8
150	150	285	240	22	22	8
200	200	340	295	22	24	8

ø mm	DN	Cod.
30	25	32423
40	32	32166
50	40	32167
60	50	32168
75	65	32169
90	80	32170
100	100	32171
125	125	32172
150	150	32173
200	200	32174

**Fig. 164-J**

### Junta válvula de pie hierro fundido

Joint valve de pied fer fondu • Junta de válvula de pé em ferro fundido

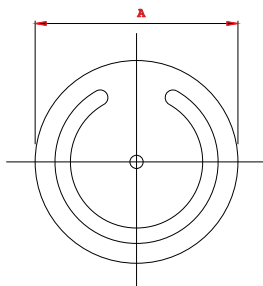

ø mm	Cod.
50	13755
60	13756
70	13757
75	13758
80	13759
90	13760
100	13761
110	13762

# ACCESORIOS EN HIERRO

ACCESSOIRES EN FER  
ACESSÓRIOS DE FERRO

**Fig. 165-JC**

## Junta válvula con contrapeso

Joint valve avec contrepoids • Junta de válvula com contrapeso



ø mm	Cod.
50	13754
60	
70	13756
75	
80	13758
90	
100	13760
110	

**Fig. 162-BC**

## Bomba cebadora de membrana

Pompes d'amorçage à membrane • Bomba cebadora de membrana



Cod.

32177

**Fig. 163-MB**

## Membrana para bomba cebadora

Membrane pour pompes d'amorçage • Membrana para bomba cebado



Cod.

32178



## ACCESORIOS EN ACERO INOXIDABLE

ACCESSOIRES EN ACIER INOXYDABLE  
ACESSÓRIOS EM AÇO INOX

---

## ACCESORIOS EN ACERO INOXIDABLE

- Material AISI-304L
- Las medidas de los tubos para la manguera son en milímetros.
- Las medidas de las roscas son en pulgadas gas.
- En los pedidos citar siempre el n.º de figura.
- **OPCIONALMENTE PODEMOS SUMINISTRAR EN ACERO INOXIDABLE AISI316, CONSÚLTENOS**

---

## ACCESSOIRES EN EN ACIER INOXYDABLE

- Matériau AISI-304L
- Les mesures des tubes pour les tuyaux sont en millimètres.
- Les mesures des filets sont en pouces gaz.
- Sur les commandes mentionner toujours le n.º de dessin.
- **EN OPTION, NOUS POUVONS FOURNIR DE L'ACIER INOX AISI316, CONTACTEZ-NOUS**

---

## ACESSÓRIOS EM AÇO INOX

- Material AISI-304L
- As medição dos tubos para as mangueiras estão em milímetros.
- As medidas das roscas estão em polegadas gás.
- Ao encomendar sempre incluir o número da figura.
- **OPCIONALMENTE, PODEMOS FORNECER O AÇO INOXIDÁVEL AISI 316, CONSULTE-NOS**

# ACCESORIOS EN ACERO INOXIDABLE

## ACCESSOIRES EN ACIER INOXYDABLE

### ACESSÓRIOS EM AÇO INOX

**Fig. 201-S**  
**Hembra para soldar • Femelle à souder • Fêmea para soldar**

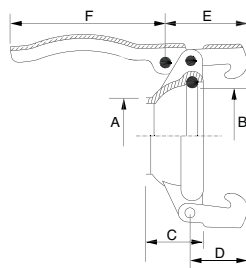

	S-3	S-5	S-7	S-10	S-12	S-15
A	(1)	56	77	95	119	144
B	72	92	111	131	153	182
C	33	51	52	60	63	69
D	43	43	55	55	55	55
E	57	60	81	81	81	81
F	122	136	160	160	160	160
Kg	0,36	0,54	0,94	1,14	1,35	1,83

Tipo	ø mm	Cod.
S-3	35	60000
	40	60001
	45	60002
	50	60003
	60	60004
S-5	60	60005
S-7	75	60006
	80	60007
	90	60008
S-10	100	60009
	110	60010
S-12	125	60011
	129	60012
S-15	150	60013

- La hembra siempre lleva incluida la junta
  - Le joint est compris avec la femelle
  - A fêmea leva sempre a junta incluída
- (1) 37 - 42 - 47 - 52 - 61

Tipo	S-3	S-5	S-7	S-10	S-12	S-15
ø mm.	20-25-30-35-40-45-50-60	60	70-75-80-90	100-110	120-125	150

**Fig. 202-S**  
**Macho para soldar • Sphère à souder • Macho para soldar**

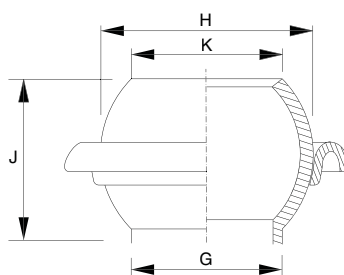

	S-3	S-5	S-7	S-10	S-12	S-15
G	(2)	56	75-89	95-114	119	144
H	70	90	110	130	150	180
J 53	73	83	90	102	104	137
K 51	63	83	100	120	145	194
Kg	0,23	0,42	0,66	0,9	1,3	2,15

Tipo	ø mm	Cod.
S-3	1"	60014
	1 1/4"	60015
	1 1/2"	60016
S-5	2"	60017
	2"	60018
S-7	2 1/2"	60019
	3"	60020
S-10	3 1/2"	60021
	4"	60022
S-12	4 1/2"	60023
S-15	5"	60024

- Los machos siempre incluyen el aro
  - Le anneau est compris avec la sphère
  - Os machos sempre incluem o anel
- (2) 34 - 43 - 49 - 61

Tipo	S-3	S-5	S-7	S-10	S-12	S-15
"Gas/Gaz	1/2"-3/4"-1"-1 1/4"-1 1/2"-2"	2"	2 1/2"-3"	3 1/2"-4"	4 1/2"	5"

# ACCESORIOS EN ACERO INOXIDABLE

## ACCESSOIRES EN ACIER INOXYDABLE

### ACESSÓRIOS EM AÇO INOX

**Fig. 208-M**

**Hembra para manguera • Femelle porte-tuyau • Fêmea para mangueira**



Tipo	Ø mm	Cod.
S-3	20	60025
	25	60026
	30	60027
	35	60028
	40	60029
	45	60030
	50	60031
	60	60032
S-5	60	
	63	60033
	65	
S-7	70	60034
	75	60035
	80	60036
	90	60037
S-10	100	60038
	110	60039
S-12	120	60040
	125	60041
S-15	150	60042

Tipo	S-3	S-5	S-7	S-10	S-12	S-15
Ø mm.	20-25-30-35-40-45-50-60	60-65	70-75-80-90	100-110	120-125	150

**Fig. 206-RE**

**Macho rosca exterior • Sphère filetage extérieur • Macho com rosca externa**



Tipo	GAS	Cod.
S-3	1/2"	60043
	3/4"	60044
	1"	60045
	1 1/4"	60046
	1 1/2"	60047
	2"	60048
S-5	2"	60049
S-7	2 1/2"	60050
	3"	60051

Tipo	S-3	S-5	S-7
"Gas/Gaz	1/2"-3/4"-1"-1 1/4"-1 1/2"-2"	2"	2 1/2"-3"

# ACCESORIOS EN ACERO INOXIDABLE

ACCESSOIRES EN ACIER INOXYDABLE  
ACESSÓRIOS EM AÇO INOX

**Fig. 205-RE**

**Hembra con rosca exterior • Femelle filetage extérieur • Fêmea com rosca exterior**



Tipo	GAS	Cod.
S-3	1/2"	60052
	3/4"	60053
	1"	60054
	1 1/4"	60055
	1 1/2"	60056
	2"	60057
S-5	2"	60058
S-7	2 1/2"	60059
	3"	60060
S-10	4"	60061
S-12	4 1/2"	60062
S-15	5"	60063
	6"	60064

Tipo	S-3	S-5	S-7	S-10	S-12	S-15
"Gas/Gaz	1/2"-3/4"-1"-1 1/4"-1 1/2"-2"	2"	2 1/2"-3"	3 1/2"-4"	4 1/2"	5"-6"

**Fig. 209-M**

**Macho para manguera • Mâle porte-tuyau • Macho para mangueira**



Tipo	ø mm	Cod.
S-3	20	60065
	25	60066
	30	60067
	35	60068
	40	60069
	45	60070
	50	60071
S-5	60	60072
	60	
	63	60073
S-7	65	
	70	60074
	75	60075
	80	60076
	90	60077

Tipo	S-3	S-5	S-7
Ø mm.	20-25-30-35-40-45-50-60	60-70	70-75-80-90



# ACCESORIOS EN ACERO INOXIDABLE

## ACCESSOIRES EN ACIER INOXYDABLE

### ACESSÓRIOS EM AÇO INOX

**Fig. 216-A**

**Aro • Anneau • Anel**

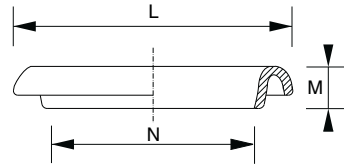

	S-3	S-5	S-7	S-10	S-12	S-15
L	93	117	147	161	185	224
M	15	23	27	29	305	37
N	63	77	96	119	140	170

Tipo	ø mm	Cod.
S-3	35	60078
	40	60079
	45	60080
	50	60081
	60	60082
S-5	60	60083
S-7	75	60084
	80	60085
	90	60086
S-10	100	60087
	110	60088
S-12	120	60089
	125	60090
S-15	150	60091

Tipo	S-3	S-5	S-7	S-10	S-12	S-15
ø mm.	20-25-30-35-40-45-50-60	60	75-80-90	100-110	120-125	150

**Fig. 217-J**

**Junta • Joint • Junta**

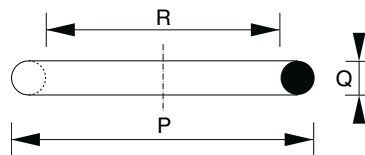

	S-3	S-5	S-7	S-10	S-12	S-15
P	80	104	125	144	168	202
Q	9	10	12	13	14	16
R	62	84	101	118	140	170

Tipo	ø mm	Cod.
S-3	20/60	60092
S-5	60/70	60093
S-7	70/90	60094
S-10	100/110	60095
S-12	125	60096
S-15	150	60097

Tipo	S-3	S-5	S-7	S-10	S-12	S-15
ø mm.	20-25-30-35-40-45-50-60	60-70	70-75-80-90	100-110	125	150

# ACCESORIOS EN ACERO INOXIDABLE

ACCESSOIRES EN ACIER INOXYDABLE

ACESSÓRIOS EM AÇO INOX

**Fig. 204-S**

**Tapón hembra** • Bouchon à femelle • Tampão fêmea



Tipo	Ø mm	Cod.
S-3	20/60	60098
S-5	60/70	60099
S-7	70/90	60100
S-10	100/110	60101
S-12	125	60102
S-15	150	60103

Tipo	S-3	S-5	S-7	S-10	S-12	S-15
Ø mm.	20-25-30-35-40-45-50-60	60-70	70-75-80-90	100-110	125	150

**Fig. 210-T**

**Tapón macho** • Bouchon mâle • Tampão macho



Tipo	Ø mm	Cod.
S-3	20/60	60104
S-5	60/70	60105
S-7	70/90	60106
S-10	100/110	60107
S-12	125	60108
S-15	150	60109

Tipo	S-3	S-5	S-7	S-10	S-12	S-15
Ø mm.	20-25-30-35-40-45-50-60	60-70	70-75-80-90	100-110	125	150

# ACCESORIOS EN ACERO INOXIDABLE

## ACCESSOIRES EN ACIER INOXYDABLE

### ACESSÓRIOS EM AÇO INOX

**Fig. 237-RM**

### Tubo rosca-manguera

Tube filet porte-tuyau • Tubo rosca-mangueira

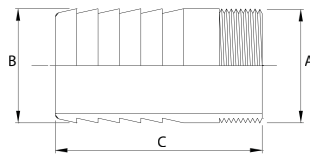

ø mm	GAS	Cod.
1/2"	20	60110
3/4"	26	60111
1"	33	60112
1 1/4"	42	60113
1 1/2"	50	60114
2"	60	60115
2 1/2"	75	60116
3"	90	60117
4"	112	60118

A	"Gas/"Gaz	1/2"	3/4"	1"	1 1/4"	1 1/2"	2"	2 1/2"	3"	4"
B	ø mm.	20	26	33	42	48	60	75	89	112
C	Long.	90	90	90	90	90	90	110	110	130

**Fig. 238-MM**

### Tubo manguera-manguera

Tube porte tuyau-porte tuyau • Tubo mangueira-mangueira

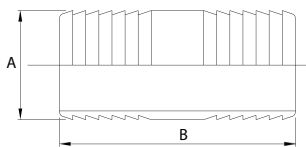

ø mm	Cod.
20	60119
25	60120
30	60121
35	60122
40	60123
45	60124
50	60125
60	60126
65	60127
70	60128
75	60129
80	60130
90	60131
100	60132
110	60133
120	60134
125	60135
140	60136
150	60137
200	60138
250	60139
300	60140

A	ø mm	20	25	30	35	40	45	50	60	65	70	75	80	90	100	110	120	125	140	150	200	250	300
B	L.	120	120	120	120	120	120	120	120	130	140	180	180	180	200	200	230	240	250	250	400	500	500

# ACCESORIOS EN ACERO INOXIDABLE

ACCESSOIRES EN ACIER INOXYDABLE  
ACESSÓRIOS EM AÇO INOX

**Fig. 248-R**

**Tubo con rosca para soldar**

Tube fileté à souder • Tubo com rosca para soldar

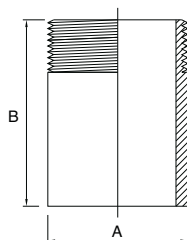

GAS	Cod.
1/2"	60141
3/4"	60142
1"	60143
1 1/4"	60144
1 1/2"	60145
2"	60146
2 1/2"	60147
3"	60148
4"	60149
5"	60150
6"	60151
8"	60152

A	"Gas/"Gaz	1/2"	3/4"	1"	1 1/4"	1 1/2"	2"	2 1/2"	3"	3 1/2"	4"	5"	6"	8"
B	L	60	60	60	60	60	65	85	90	100	115	120	125	180

**Fig. 249-M**

**Tubo con regatas para soldar**

Tube porte-tuyau à souder • Tubo pegas para soldar

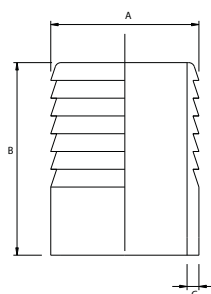

ø mm	Cod.
20	60153
25	60154
30	60155
35	60156
40	60157
45	60158
50	60159
60	60160
65	60161
70	60162
75	60163
80	60164
90	60165
100	60166
110	60167
120	60168
125	60169
140	60170
150	60171
200	60172
250	60173
300	60174

A	ø mm	20	25	30	35	40	45	50	60	65	70	75	80	90	100	110	120	125	140	150	200	250	300
B	L.	65	65	65	65	65	65	65	70	75	90	105	105	110	110	120	130	130	135	140	200	250	300
C		2	2	2	2	2	2	2	2	2	2	2	2	3	3	3	3	3	3	3	3	3	3

ACCESORIOS EN ACERO INOXIDABLE • ACCESSOIRES EN ACIER INOXYDABLE • ACESSÓRIOS EM AÇO INOX

---

## ACCESORIOS EN PLÁSTICO

- **MATERIAL:** Poliamida (Nylon 66) PA, o polipropileno
- **COLOR:** Natural o negro (polipropileno)
- **PRESIÓN DE EJERCICIO:** 16 bar a 20°C
- **temperatura máxima de ejercicio:** 90°C

---

## ACCESSOIRES EN PLASTIQUE

- **MATÉRIEL:** Polyamide (nylon 66) PA ou polypropylène
- **COULEUR:** Naturel ou noir (polypropylène)
- **PRESSION D'EXERCICE:** 16 bar à 20°C
- **TEMPÉRATURE D'EXERCICE MAXIMUM:** 90°C

---

## ACESSÓRIOS EM PLÁSTICO

- **MATERIAL:** poliamida (nylon 66) pa ou polipropileno
- **COULEUR:** naturel ou preto (polipropileno)
- **PRESSÃO DE EXERCÍCIO:** 16 bar à 20°C
- **TEMPERATURA MÁXIMA DE EXERCÍCIO :** 90°C

# ACCESORIOS EN PLÁSTICO

## ACCESSOIRES EN PLASTIQUE

## ACESSÓRIOS EM PLÁSTICO

**Fig. 1 - 0200010\*\***

### Medio racor H C/Enlace

Demi raccord avec connecteur

Racord médio H com união



GxG1	Código Code Código	u. x bolsa Pcs x.enveloppe u. x saco
25 x 25	<b>12777</b>	100
30 x 30	<b>12435</b>	100
35 x 35	<b>13158</b>	100
40 x 40	<b>12778</b>	100
50 x 50	<b>12779</b>	50
60 x 60	<b>32233</b>	50

**Fig. 2 - 0200020\*\***

### Medio racor M

Demi raccord M • Racord médio M



GxG1	Código Code Código	u. x bolsa Pcs x.enveloppe u. x saco
25 x 25	<b>12780</b>	100
30 x 30	<b>13202</b>	100
35 x 35	<b>12781</b>	100
40 x 40	<b>12782</b>	100
50 x 50	<b>12783</b>	50
60 x 60	<b>32234</b>	50

**Fig. 3 (Fig. 1+Fig. 2) 0200042**

### Racor en 3 pzas manguera-manguera

Raccord 3 pièces tuyau-tuyau • Racord em 3 peças mangueira-mangueira



GxG1	Código Code Código	u. x bolsa Pcs x.enveloppe u. x saco
25 x 25	<b>12784</b>	10
30 x 30	<b>13203</b>	10
35 x 35	<b>12785</b>	10
40 x 40	<b>12786</b>	10
50 x 50	<b>12787</b>	5
60 x 60	<b>32235</b>	5

**Fig. 4 - 0200030\***

**Racor intermedio M-M**

Raccord intermède M-M • Racord intermédio M-M



GxG1	Código Code Código	u. x bolsa Pcs x.enveloppe u. x saco
1" x 25	<b>31612</b>	100
1" x 30	<b>12436</b>	100
1" x 35	<b>12641</b>	100
1" 1/4 x 40	<b>17164</b>	100
1" 1/2 x 35	<b>12788</b>	100
1" 1/2 x 40	<b>12789</b>	100
1" 1/2 x 50	<b>12790</b>	50
2" x 50	<b>31275</b>	50
2" x 60	<b>32237</b>	24

**Fig. 5 (Fig. 1+Fig. 4) 0200044**

**Medio racor M recto en 3 pzas**

Demi raccord M droit en 3 pièces

Racord médio M recto em 3 pedaços



GxG1	Código Code Código	u. x bolsa Pcs x.enveloppe u. x saco
1" x 25	<b>31611</b>	10
1" x 30	<b>12434</b>	10
1" x 35	<b>13172</b>	10
1" 1/4 x 40	<b>17165</b>	10
1" 1/2 x 35	<b>12843</b>	10
1" 1/2 x 40	<b>12791</b>	10
1" 1/2 x 50	<b>12792</b>	5
2" x 50	<b>31276</b>	5
2" x 60	<b>32236</b>	5

**Fig. 6 - 0200040\***

**Medio racor H c/enlace curvo**

Demi raccord F courbe avec connecteur • Racord médio H com união curva



GxG1	Código Code Código	u. x bolsa Pcs x.enveloppe u. x saco
25 x 25	<b>32242</b>	100
30 x 30	<b>13204</b>	100
35 x 35	<b>12793</b>	100
40 x 40	<b>12794</b>	100
50 x 50	<b>12795</b>	50

# ACCESORIOS EN PLÁSTICO

## ACCESSOIRES EN PLASTIQUE

## ACESSÓRIOS EM PLÁSTICO

**Fig. 7 (Fig 4+Fig.6)0200046**  
**Racor M curvo en 3 pzas**  
 Raccord M courbe 3 pièces  
 Racord curvo M em 3 peças



GxG1	Código Code Código	u. x bolsa Pcs x.enveloppe u. x saco
1" x 25	<b>32243</b>	10
1" x 30	<b>13205</b>	10
1" x 35	<b>12796</b>	10
1" 1/4 x 40	<b>17166</b>	10
1" 1/2 x 35	<b>12844</b>	10
1" 1/2 x 40	<b>12797</b>	10
1" 1/2 x 50	<b>12798</b>	5
2" x 50	<b>73988</b>	5

**Fig. 11 - 0200130**  
**Portamang. recto rosca gas M**  
 Raccord droit pour tuyau filetage gaz M  
 Portamangueiras recto rosca gas M



GxG1	Código Code Código	u. x bolsa Pcs x.enveloppe u. x saco
1"x 25	<b>12101</b>	10
1"x 30	<b>32213</b>	10
1" 1/4 x 30	<b>32215</b>	10
1" 1/4 x 35	<b>13159</b>	10
1" 1/4 x 40	<b>13160</b>	10
1" 1/2 x 40	<b>13639</b>	5
1" 1/2 x 50	<b>13161</b>	5
2"x50	<b>32216</b>	5
2" x 60	<b>13162</b>	5

**Fig. 12 - 0200720**  
**Válvula de fondo hembra-pom**  
 Crépine de fond F  
 Válvula inferior fêmea-pom



GxG1	Código Code Código	u. x bolsa Pcs x.enveloppe u. x saco
1"	<b>10824</b>	5



**Fig. 12 - 0200730**  
**Válvula de fondo hembra-pom**  
 Crépine de fond F  
 Válvula inferior fêmea-pom



GxG1	Código Code Código	u. x bolsa Pcs x.enveloppe u. x saco
1"1/4	<b>10842</b>	5
1" 1/2	<b>10826</b>	5
2"	<b>10800</b>	5

**Fig.14 - 9100000**  
**Filtro de pie mang. polipropileno**  
 Protecteur de fond tuyau  
 Pe de filtro mangueira polipropileno



\* 13168, 13169



12437,13173,15853

GxG1	Código Code Código	u. x bolsa Pcs x.enveloppe u. x saco
25	<b>13168</b>	5
30	<b>12437</b>	5
35	<b>13173</b>	5
40	<b>13169</b>	5
50	<b>15853</b>	5

**Fig. 16 - 0200120**  
**Portamang. rectoc/enlace y junta**  
 Raccord droit pour tuyau avec connecteur et joint  
 Portamangueiras de rosca reta com união e junta



GxG1	Código Code Código	u. x bolsa Pcs x.enveloppe u. x saco
1" x 25	<b>11818</b>	10
1" 1/4" x 30	<b>32461</b>	10
1" 1/2 x 40	<b>32221</b>	5
2" x 50	<b>11201</b>	5

# ACCESORIOS EN PLÁSTICO

ACCESSOIRES EN PLASTIQUE  
ACESSÓRIOS EM PLÁSTICO

**Fig. 17 - 0200125\***  
**Junta plana en epdm**  
Joint plat • Junta plana em epdm



GxG1	Código Code Código	u. x bolsa Pcs x.enveloppe u. x saco
1" F-1/2" M	<b>11821</b>	100
2" F	<b>13670</b>	50

**Fig. 18 - 0200210**  
**Machón** • Raccord M-M • Macho



GxG1	Código Code Código	u. x bolsa Pcs x.enveloppe u. x saco
1"	<b>31610</b>	20
1" 1/4	<b>32462</b>	10
1" 1/2	<b>31635</b>	10
2"	<b>32463</b>	10

**Fig. 18 - 0200211**  
**Machón reductor** • Raccord M-M réducteur • Macho reductor



GxG1	Código Code Código	u. x bolsa Pcs x.enveloppe u. x saco
1" x 3/4"	<b>32288</b>	20
1" 1/4 x 1"	<b>32289</b>	10
1" 1/2 x 1"	<b>14924</b>	10
1" 1/2 x 1" 1/4	<b>31636</b>	10
2" x 1" 1/2	<b>32262</b>	10

**Fig. 19 - 0200170**

**Filtro con rosca gas H**

Filtre avec filetage gaz F • Filtro com gás H



GxG1	Código Code Código	u. x bolsa Pcs x.enveloppe u. x saco
1"	<b>15111</b>	5
1"1/4	<b>15112</b>	5
1"1/2	<b>15113</b>	5
2"	<b>15114</b>	5

**Fig. 46 - 0200121**

**Portamang. curvo c/enlace y junta**

Raccord courbe pour tuyau avec connecteur et joint

Portamangueiras de rosca curva com união e junta



GxG1	Código Code Código	u. x bolsa Pcs x.enveloppe u. x saco
1" x 25	<b>32464</b>	10
1"1/4 x 30	<b>31632</b>	10
1"1/2 x 40	<b>31634</b>	5
2" x 50	<b>18718</b>	5

CONVERSIÓN UNIDAD DE MEDIDA / UNITÉ DE CONVERSION DE LA MESURE / UNIDADE DE CONVERSÃO DA MEDIDA										
Diámetro en mm	13	16	19	20	22	25	32	38	50	63
Diámetro en pulgadas	1/2"	5/8"	3/4"	3/4"	7/8"	1"	1/4	1"1/2	2"	2"1/2

# ACCESORIOS EN PLÁSTICO

ACCESSOIRES EN PLASTIQUE  
ACESSÓRIOS EM PLÁSTICO

## MANGUERA FLEXIBLE DE PVC BLANDO CON ESPIRAL DE REFUERZO EN PVC RÍGIDO EMBUTIDO TUYAU FLEXIBLE EN PVC SOUPLE AVEC SPIRAL DE RENFORCEMENT EN PVC RIGIDE FOURRE MANGUEIRA FLEXÍVEL DE PVC COM ESPIRAL (INTERIOR REFORÇADO COM PVC RIGIDO)



Código Code Código	Ø Int (mm)	Ø Ext (mm)	Peso Poids/ Peso (g/m)	Trabajo Travail / Trabalho (bar)	Vacío Vide / Vácuo (m H <sub>2</sub> O)	m x rollo m x rouleau m x rolo	Rollo/Rouleau/Rolo Código
9933	25	29,8	250	6,5	7	50	9933R
9934	30	35	330	6	7	50	9934R
27271	35	40,4	400	6	7	50	27271R
9935	40	46	480	5,5	7	50	9935R
27272	50	58,2	760	5,5	7	50	27272R
27273	60	68,6	900	4	7	50	27273R
27274	70	79	1125	3	7	50	27274R
16699	75	84,4	1200	3	7	50	16699R
9996	80	89,4	1450	3	7	25	33645R 25M
27275	90	100,4	1800	4	7	25	33655R 25M
27276	100	112	2160	4	7	25	33656R 25M
9997	110	122	2400	4	6	25	33657R 25M
17512	125	137,6	3130	3	6	25	33658R 25M
18900	150	164,4	4250	3	5	25	33659R 25M
29016	200	218,2	6400	2	5	10	33660R 10M

Manguera de riego •  
Tuyau d'arrosage • Mangueira de rega



Temperatura de empleo de -10° C hasta +60° C.

Los valores de presión y trabajo incluidos se refieren a temperatura de 20° C.

Température d'utilisation de -10° C jusqu'à +60° C.

Les valeurs de pression et travail indiqués se réfèrent à températures de 20° C.

Temperatura de Operação -10° C a +60° C.

Os valores de pressão e de trabalho incluídos referem-se à temperatura de 20° C.

**APLICACIONES:** Aspiración y trasiego de aguas potables, soluciones alimentarias, etc.  
Para la conducción de líquidos en general en la industria y en la agricultura.

**APPLICATIONS:** Aspiration et transport d'eaux potables, liquides alimentaires etc.

Pour la conduction de liquides en général dans les secteurs de l'industrie et l'agriculture.

Aplicações: sucção e transferência de água potável, soluções alimentarias, etc.

Para a condução de líquidos na indústria em geral e na agricultura.



## MANGUERA PLANA DE PVC REFORZADA CON FIBRA DE POLIESTER, PARA IMPULSION A PRESION DE LIQUIDOS EN GENERAL

TUYAU PLAT EN PVC RENFORCÉ DE FIBRE DE POLYESTER, POUR LA IMPULSION A PRESSION DES LIQUIDES EN GÉNÉRAL

MANGA PLANA DE PVC REFORÇADA COM FIO DE POLIÉSTER, PARA IMPULSÃO A PRESSÃO DE LÍQUIDOS EM GERAL



Código Code Código	Ø Int (mm)	Ø Ext (mm)	Peso Poids Peso (g/m)	Trabajo Travail Trabalho (bar) a 20°C	Trabajo Travail Trabalho (bar) a 40°C	Trabajo Travail Trabalho (bar) a 60°C	Rotura Rupture Ruptura (bar) a 20°C	m x rollo m x rouleau m x rolo	Rollo/Rouleau/Rolo Código
32589	25	28	155	8,5	7	4	25,5	50	32589 R
32590	32	35	210	8,5	7	4	25,5	50	32590 R
32591	35	38	220	8,5	7	4	25,5	50	32591 R
32592	38	41	240	8,5	7	4	25,5	50	32592 R
32593	40	43	250	8,5	7	4	25,5	50	32593 R
32594	45	48	280	6,5	5	2,5	19,5	50	32594 R
32293	51	54	320	6,5	5	2,5	19,5	50	32293 R
32595	60	64	360	6,5	5	2,5	19,5	50	32595 R
32597	70	74	450	5,5	4	2	16,5	50	32597 R
32294	76	80	520	5,5	4	2	16,5	50	32294 R
32598	80	84	580	5,5	4	2	16,5	50	32598 R
32599	90	94	660	5,5	4	2	16,5	50	32599 R
32295	102	106	720	5,5	4	2	16,5	50	32295 R
32601	110	115	780	5,5	4	2	16,5	50	32601 R
32296	127	132	1130	3	2	0,5	9	50	32296 R
32297	152	157	1350	3	2	0,5	9	50	32297 R
32602	204	209	2000	2,5	1,5	0,3	7	50	32602 R



Temperatura de empleo de -10° C hasta +60° C.

Los valores de presión y trabajo incluidos se refieren a temperatura de 23° C ± 2° C (ISO 291)

Température d'utilisation de -10° C jusqu'à +60° C.

Les valeurs de pression et travail indiqués se réfèrent à températures de 23° C ± 2° C (ISO 291)

Temperatura de Operação -10° C a +60° C.

Os valores de pressão e de trabalho incluídos referem-se à temperatura de 23° C ± 2° C (ISO 291)

### APLICACIONES: Impulsión de líquidos en general

APPLICATIONS: Principalement pour l'acheminement de l'eau à des pressions basses

APLICAÇÕES: Principalmente na condução de água a baixas pressões

# INFORMACIÓN TÉCNICA

INFORMATION TECHNIQUE  
INFORMAÇÃO TÉCNICA

## Esquema de instalación de una electrobomba / motobomba Schéma d'installation d'une pompe électrique / motopompe Esquema de instalação de uma electrobomba / motobomba

### ALTURA GEOMÉTRICA

Es la altura medida verticalmente desde el nivel del agua o líquido a elevar, hasta el punto más alto. Esta altura se divide en dos:

Altura de aspiración: Es la distancia desde el nivel del agua hasta el eje de la turbina.

Altura de impulsión: Es la distancia desde el eje de la turbina hasta el punto de máxima elevación.

### ALTURA MANOMÉTRICA

Es la suma de la altura geométrica más las pérdidas de carga, o sea, la presión efectiva que ha de vencer la bomba para elevar el agua desde su nivel más bajo hasta el punto de elevación más alto.

### PERDIDAS DE CARGA

Es la resistencia que encuentra el agua por rozamiento en su paso por el interior de las tuberías y accesorios en todo su recorrido. Para su cálculo consultar la tabla correspondiente.

### HAUTEUR GÉOMÉTRIQUE

Il s'agit de la hauteur mesurée verticalement depuis le niveau de l'eau ou du liquide à élever jusqu'au point le plus élevé. Cette hauteur est divisée en deux :

Hauteur d'aspiration : C'est la distance entre le niveau de l'eau et l'axe de la turbine.

Hauteur d'entraînement: C'est la distance de l'axe de la turbine au point d'élévation maximale.

### HAUTEUR MANOMÉTRIQUE

C'est la somme de la hauteur géométrique plus les pertes de charge, c'est-à-dire la pression effective que la pompe doit surmonter pour faire monter l'eau de son niveau le plus bas au point d'altitude le plus élevé.

### PERTES DE CHARGE

C'est la résistance que l'eau rencontre par frottement lorsqu'elle passe à l'intérieur des tuyaux et des raccords tout au long de son trajet. Pour les calculer, consultez le tableau correspondant.

### ALTURA GEOMÉTRICA

É a altura medida verticalmente desde o nível da água ou líquido a elevar, até ao ponto mais alto. Esta altura divide-se em duas:

Altura de aspiração : É a distância desde o nível da água até ao eixo / veio da turbina.

Altura de impulsão : É a distância desde o eixo / veio da turbina até ao ponto de elevação máxima.

### ALTURA MANOMÉTRICA

É a soma da altura geométrica mais as perdas de carga, ou seja, a pressão efectiva a ser superada pela bomba para levar a água do seu nível mais baixo ao ponto mais alto de elevação.

### PERDAS DE CARGA

É a resistência que a água encontra por atrito ao passar pelo interior dos tubos / canos e conexões ao longo de seu caminho. Para o seu cálculo, consulte a tabela correspondente.

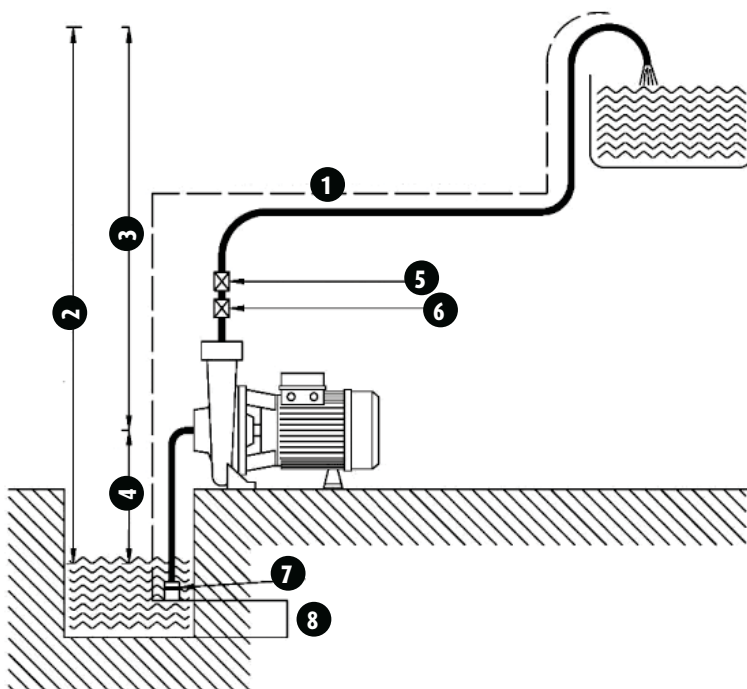

- 1 Recorrido total de la tubería  
Trajet total du tuyau  
Percorso/distância total da tubagem
- 2 Altura geométrica  
Hauteur géométrique  
Altura geométrica
- 3 Altura impulsión  
Hauteur d'entraînement  
Altura de impulsão
- 4 Aspiración  
Aspiration  
Aspiração
- 5 Válvula de compuerta  
Vanne d'arrêt  
Válvula de comporta
- 6 Válvula de retención  
Clapet anti-retour  
Válvula de retenção
- 7 Válvula de pie  
Clapet de pied  
Válvula de pé
- 8 Separación del fondo  
Séparation inférieure  
Separação do fundo

## Tabla de pérdidas de carga (Tuberías de PVC / Polietileno)

Table de perte de charge (tuyaux en PVC / polyéthylène)  
Tabela de queda de pressão (tubos de PVC / polietileno)

Por rozamiento del agua en las tuberías, expresada en metros por cada 100 m de tubería recta.  
Advertimos que para el cálculo de pérdidas de carga, debe tenerse en cuenta que, cada curva de 90° equivale a 5 m de recorrido de tubería, cada válvula de compuerta a 5 m y cada válvula de pie a 15 m.

Par frottement de l'eau dans les tuyaux, exprimé en mètres pour 100 m de tuyau droit.  
Nous avertissons que pour le calcul des pertes de charge, il faut tenir compte du fait que chaque coude à 90° équivaut à 5 m de longueur du tuyau, chaque vanne d'arrêt à 5 m et chaque clapet de pied à 15 m.

Por fricção da água nos canos, expressa em metros por cada 100 m de cano recto.  
Observamos que, para o cálculo das perdas de carga, deve-se levar em consideração que cada curva de 90° é equivalente a 5m de curso do tubo, cada válvula de gaveta a 5m e cada válvula de pé a 15m.

Q(l/h)	Diámetro interior de la tubería en mm. / Diamètre intérieur du tuyau en mm. / Diâmetro interno do tubo em mm.											
	14	19	25	32	38	50	63	75	89	100	125	150
Metros de columna de agua por 100 m de recorrido recto / Mètres de colonne d'eau par 100 m. de trajet droit / Medidores de coluna de água por 100 m de caminho recto												
500	8,9	2,1	0,6									
800	20,2	4,7	1,3	0,4								
1000	29,8	7	1,9	0,6								
1500		14,2	3,9	1,2	0,5							
2000		23,5	6,4	2	0,9							
2500			9,4	2,9	1,3	0,4						
3000			13	4	1,8	0,5	0,2					
3500			17	5,3	2,3	0,6	0,2					
4000			21,5	6,6	2,9	0,8	0,3	0,1				
4500				8,2	3,6	1	0,3	0,1				
5000				9,8	4,3	1,2	0,4	0,2				
5500				11,6	5,1	1,4	0,5	0,2				
6000				13,5	6	1,6	0,5	0,2				
6500				15,5	6,9	1,9	0,6	0,3				
7000				17,7	7,8	2,1	0,7	0,3				
8000				22,4	9,9	2,7	0,9	0,4	0,2			
9000					12,1	3,3	1,1	0,5	0,2			
10000					14,6	4	1,3	0,6	0,3	0,1		
12000					20,1	5,5	1,8	0,8	0,4	0,2		
15000					29,7	8,1	2,7	1,2	0,5	0,3		
18000						11,1	3,7	1,6	0,7	0,4	0,1	
20000						13,3	4,5	1,9	0,9	0,5	0,2	
25000						19,7	6,6	2,9	1,3	0,7	0,3	
30000							9	4	1,8	1	0,3	0,1
35000							11,8	5,2	2,3	1,3	0,5	0,2
40000							15	6,5	2,9	1,7	0,6	0,2
45000							18,4	8	3,6	2	0,7	0,3
50000								9,7	4,3	2,5	0,9	0,4
60000								13,3	5,9	3,4	1,2	0,5
70000									7,7	4,4	1,5	0,6
80000									10,4	5,6	1,9	0,8
90000									12,9	7,3	2,4	1
100000										8,9	2,9	1,2
125000											4,5	1,8
150000											6,3	2,6
175000											8,4	3,5
200000											10,7	4,4
250000												6,7
300000												9,3

Para otras tuberías recomendamos multiplicar los valores obtenidos en la tabla por los siguientes coeficientes:  
Tuberías de fibrocemento: 1,2  
Tuberías de hierro galvanizado: 1,5

Pour d'autres types de tuyaux, nous recommandons multiplier les valeurs obtenues dans le tableau par les coefficients suivants :  
Tuyaux en fibrociment : 1,2  
Tuyaux en fer galvanisé : 1,5

Para otras tubagens recomendamos multiplicar os valores obtidos na tabela pelos seguintes coeficientes:  
Tubagem de fibrocimento: 1,2  
Tubagem de ferro galvanizado: 1,5

## NPSH (Net Positive Suction Head)

Este parámetro indica la incapacidad de la bomba de crear el vacío absoluto, o sea la incapacidad de todas las bombas centrífugas de aspirar a una altura igual o superior a 10,33 m (que corresponde generalmente al valor de la presión atmosférica al nivel del mar).

Desde el punto de vista físico, el NPSH indica la presión absoluta que debe existir en el ingreso de la bomba para que no surjan fenómenos de cavitación. Cuando una bomba trata de aspirar cierta cantidad de líquido de una profundidad superior a la permitida por sus características, sucede precisamente el fenómeno de la cavitación, el rodete interrumpe el ventero y por consiguiente se forman pequeñas burbujas de vapor; poco después estas burbujas forman implosiones generando un ruido parecido a un martilleo metálico y crean serios daños a las piezas hidráulicas de la bomba.

Esta es pues la razón por la cual todo fabricante de bombas indica claramente, entre las características de sus máquinas, la máxima altura de aspiración, o suministra la curva NPSH en función del caudal. Máxima altura de aspiración Hmax y NPSH están ligadas entre ellas por la relación:

$$H_{max} = A - NPSH - H_{asp} - H_r (m)$$

donde "A" = presión absoluta en m existente en la superficie libre del fluido en el depósito de aspiración: si se aspira por un depósito "abierto", o sea en contacto con la atmósfera, "A" equivale a la presión atmosférica; H<sub>asp</sub> = pérdidas de carga en la conducción de aspiración en m; H<sub>r</sub> = tensión del vapor del líquido transportado en m.

El NPSH es influenciado por el valor del caudal: crece con el aumento de este último y de esto resulta que para reconducir la bomba a un funcionamiento normal, a menudo es suficiente con parcializar la compuerta de la válvula en modo apropiado para reducir así el caudal de la bomba misma.

Como puede notarse por la expresión antes escrita, para aumentar la máxima altura de aspiración de determinada bomba se pueden disminuir las pérdidas de carga H<sub>asp</sub> de la conducción de aspiración: por esta razón siempre es conveniente montar en la aspiración una tubería cuyo diámetro interno sea lo más grande posible.

Ce paramètre indique l'incapacité de la pompe à créer le vide absolu, c'est-à-dire l'incapacité de toutes les pompes centrifuges à aspirer à une hauteur égale ou supérieure à 10,33 m (correspondant généralement à la valeur de la pression atmosphérique au niveau de la mer). D'un point de vue physique, le NPSH indique la pression absolue qui doit exister dans l'entrée de la pompe pour éviter les phénomènes de cavitation. Quand une pompe essaie d'aspirer une certaine quantité de liquide à une profondeur supérieure à celle permise par ses caractéristiques, le phénomène de cavitation se produit, la turbine ne fonctionne pas correctement et par conséquent de petites bulles de vapeur se forment; peu de temps après de sa formation, se produit une implosion des bulles. Cette implosion peut être si violente que la pression et la température à l'intérieur de la bulle, peuvent prendre des valeurs très élevées. En implosant, la bulle peut émettre une onde de choc dans le liquide, qui permet

de casser des gouttes, de disperser, désagglomérer ou briser des particules solides, ou encore de nettoyer ou éroder des surfaces solides.

C'est la raison pour laquelle chaque fabricant de pompes indique clairement, parmi les caractéristiques, la hauteur d'aspiration maximale, ou fournit la courbe NPSH basé sur le débit. La hauteur d'aspiration maximale Hmax et NPSH sont liées entre eux pour la relation :

$$H_{max} = A - NPSH - H_{asp} - H_r (m)$$

où "A" = pression absolue en m existant sur la surface libre du fluide dans le réservoir d'aspiration: s'il est aspiré à travers un réservoir «ouvert», c'est-à-dire en contact avec l'atmosphère, "A" est égal à la pression atmosphérique;

H<sub>asp</sub> = perte de charge dans la conduite d'aspiration en m; H<sub>r</sub> = tension de la vapeur du liquide transporté en m. Le NPSH est influencé par la valeur du débit: il croît avec l'augmentation de ce dernier et, par conséquent, pour ramener la pompe à un fonctionnement normal, il est souvent suffisant réduire la porte de la vanne en mode approprié pour réduire le débit de la pompe elle-même. Comme on peut le voir à partir de l'expression précédemment écrite, pour augmenter la hauteur maximale d'aspiration d'une pompe, on peut réduire les pertes de charge H<sub>asp</sub> de la ligne d'aspiration: pour cette raison, il est toujours pratique de monter sur l'aspiration un tuyau dont le diamètre intérieur est le plus grand possible.

Este parâmetro indica a incapacidade da bomba de criar o vácuo absoluto, ou seja, a incapacidade de todas as bombas centrífugas de sugar a uma altura igual ou superior a 10,33 m (o que geralmente corresponde ao valor da pressão atmosférica no nível do mar). Do ponto de vista físico, o NPSH indica a pressão absoluta que deve existir na entrada da bomba para que não ocorram fenômenos de cavitação. Quando uma bomba tenta sugar uma certa quantidade de líquido a uma profundidade maior que a permitida por suas características, o fenômeno da cavitação ocorre com precisão, o impulsor interrompe o funcionamento e consequentemente pequenas bolhas de vapor são formadas; logo após essas bolhas formam implosões, gerando um ruído semelhante a um martelo metálico e causando sérios danos às peças bomba hidráulica. Essa é a razão pela qual todo fabricante de bombas indica claramente, entre as características de suas máquinas, a cabeça de sucção máxima ou fornece a curva NPSH, dependendo do fluxo. A altura máxima de sucção Hmax e NPSH são ligadas uma à outra pela relação:

$$H_{max} = A - NPSH - H_{ferro} - H_r (m)$$

onde "A" = pressão absoluta em m existente na superfície livre do fluido no tanque de sucção: se for aspirado através de um tanque "abierto", ou seja, em contato com a atmosfera, "A" é equivalente à pressão atmosférica; H<sub>ferro</sub> = perda de carga na linha de sucção em m; H<sub>r</sub> = tensão do vapor do líquido transportado em m. O NPSH é influenciado pelo valor do fluxo: aumenta com o aumento do último e segue-se que, para retornar a bomba à operação normal, muitas vezes é suficiente dividir parcialmente o portão da Válvula no modo apropriado para reduzir o fluxo da própria bomba. Como pode ser visto

na expressão acima, para aumentar a cabeça de sucção máxima de uma determinada bomba, é possível diminuir as perdas de carga de H<sub>asp</sub> da linha de sucção: por esse motivo, é sempre conveniente montar um tubo com um diâmetro interno de maior possível.

### Influencia de la altura y temperatura del agua en la aspiración de una bomba.

Influence de la hauteur et de la température de l'eau sur l'aspiration d'une pompe

Influência da altura e temperatura da água na aspiração de uma bomba.

Altura sobre el nivel del mar Hauteur au-dessus du niveau de la mer Altura acima do nível do mar	Reducción o pérdida en la aspiración Réduction ou perte à l'aspiration Redução ou perda de aspiração	Temperatura Température Temperatura	Reducción o pérdida en la aspiración Réduction ou perte à l'aspiration Redução ou perda de aspiração
(m)	(m)	(°C)	(m)
0	0	10	0,13
100	0,13	15	0,17
200	0,25	20	0,24
300	0,38	25	0,32
400	0,50	30	0,43
500	0,63	35	0,57
600	0,75	40	0,75
700	0,87	45	0,97
800	0,99	50	1,25
900	1,11	55	1,60
1000	1,22	60	2,04
1100	1,33	65	2,55
1200	1,44	70	3,16
1300	1,55	72	3,45
1400	1,66	74	3,77
1500	1,77	76	4,10
1600	1,88	78	4,45
1700	1,99	80	4,80
1800	2,09	82	5,22
1900	2,19	84	5,65
2000	2,29	86	6,12
2200	2,49	88	6,62
2400	2,68	90	7,15
2600	2,87	92	7,71
2800	3,05	94	8,31
3000	3,23	96	8,95
3500	3,65	98	9,60
4000	4,06	100	10,33



# INFORMACIÓN TÉCNICA

INFORMATION TECHNIQUE

INFORMAÇÃO TÉCNICA

**Como escoger un grupo electrógeno idóneo para el accionamiento de un motor eléctrico**

Comment choisir un groupe électrogène convenable pour entraîner un moteur électrique

Como escolher um grupo gerador adequado para acionar um motor elétrico

VOLTAJE / TENSION / TENSÃO	MOTOR ELÉCTRICO MOTEUR ÉLECTRIQUE MOTOR ELÉTRICO		GRUPO ELECTRÓGENO / GROUPE ÉLECTROGÈNE / GRUPO ELÉTRICO					
	Potencia nominal Puissance nominale Potência nominal		Arranque directo Démarrage direct Início direto		Arranque Estrella-Triángulo Démarreur triangle étoile Início do triângulo estrela		Arranque Electrónico Progresivo por variador Démarrage électronique progressif par variateur Partida electrónica progresiva por variador	
			Potencia aparente Puissance apparente Potência aparente	Potencia activa Puissance actif Potência ativa	Potencia aparente	Potencia activa	Potencia aparente	Potencia activa
	KW	CV	KVA	KW	KVA	KW	KVA	KW
MONOFÁSICO MONOPHASE MONOFÁSICA	0,55	0,75	3	2,4	--	--	--	--
	0,75	1	3,5	2,8	--	--	--	--
	1,1	1,5	4,5	3,6	--	--	--	--
	1,5	2	5,5	4,4	--	--	--	--
	2,2	3	7,5	6	--	--	--	--
TRIFÁSICO / TRIPHASE / TRIFÁSICA	0,75	1	3,5	2,8	--	--	--	--
	1,1	1,5	4,5	3,6	--	--	--	--
	1,5	2	5,5	4,4	--	--	--	--
	2,2	3	7,5	6	--	--	--	--
	3	4	10	8	--	--	--	--
	4	5,5	12,5	10	10	8	--	--
	5,5	7,5	15,6	12,5	13,8	11	--	--
	7,5	10	18,8	15	17,5	14	--	--
	9,2	12,5	24	19	21	17	--	--
	11	15	28	22,5	26	21	--	--
	13	17,5	33	26,5	30	24	--	--
	15	20	37,5	30	35	28	25	20
	16,5	22,5	41	33	37,5	30	27,5	22
	18,5	25	46	37	42,5	34	30	24
	20	27,5	50	40	46,5	37	35	38
	22	30	56,3	45	51	41	40	32
	26	35	65	52	56	45	45	36
	30	40	75	60	65	52	50	40
	33,5	45	82,5	66	71	57	55	44
	37	50	94	75	80	64	60	48
40	55	100	80	86	69	70	56	
45	60	112	90	97	78	75	60	
51,5	70	131	105	111	89	95	76	
55	75	138	110	119	95	100	80	
66	90	169	135	142	114	115	92	
75	100	188	150	162	130	125	100	
90	125	231	185	195	156	150	120	
110	150	263	210	237	190	200	160	
130	175	325	260	281	225			
150	200	375	300	325	260			







**WARNING**



Check that there is no any fuel spilling or fuel leakage. Filling fuel before stopping the engine is forbidden

**CAMPEONINI** TM

## **MOTORES CAMPEÓN**

**C/ Galileo 2 - Naves 1, 2, 3 - Pol. Ind. Autopista**

**08150 Parets del Vallès, Barcelona**

**Tel. 935 444 420**

**Fax. 935 444 423**

**e-mail: [info@campeon.es](mailto:info@campeon.es)**

**[www.campeongroup.es](http://www.campeongroup.es)**